

TECHLINE[®]

IMPROVING THE MILEAGE



Focus on
Marine

LINAK.COM/TECHLINE

LINAK[®] 
WE IMPROVE YOUR LIFE



Unique movement solutions for increased comfort at sea

From small motor boats to sailboats and yachts – regardless of the type of your boat, LINAK® can help you design all kinds of adjustable features both above and below deck. With a variety of versatile high-quality electric actuator solutions, movement has never been easier to integrate.

When your customers step onto their boat, yacht or other recreational vessel, they will expect comfort and intuitive usability – some even luxury living conditions. Integrating movement solutions in your boat design will help meet these demands, while utilising the limited space available. LINAK is ready to support this design journey with tried and tested actuator solutions that are easily implemented and adapted.

For all boats it is often critical that products work under extreme conditions. LINAK actuators are capable and well suited for use in corrosive environments where salt, water, wind and sun wear out equipment quickly. Our actuators can be adapted to even harsher conditions with stainless steel elements, and the actuators require no maintenance.

With 30 subsidiaries worldwide and more than 30 years of experience with actuator technology, LINAK is accessible, capable and ready to help you add value to your yacht with electric movement.

LINAK actuators are capable and well suited for use in corrosive environments where salt, water, wind and sun wear out equipment quickly.

LINAK offers service
worldwide

Please contact your local LINAK office with
your enquiry



Turn your sofa into a sun lounger

To optimise the usage of the limited space on board yachts and sailboats, creative solutions are much appreciated among sailors. Turning a sofa into a lounger on the yacht's sun deck is such an idea.

Adding movement to leisure furniture in general is a LINAK® speciality. We have years of experience in developing elegant and comfort-enhancing adjustment. Our electric actuators offer smooth motion, effortless operation, and take comfort to the next level. Integrating solutions with overall boat design is easy and will provide seamless pleasure for many years on board your ship.

[Sofa to sun lounger](#)
Fold a sofa into a lounger
for increased comfort.



Retract folding roofs and lower radar arches

Integrating electric actuators in radar arches and folding roofs will, first of all, help you get the most out of the space. However, using LINAK solutions to do the job has several other advantages.

Radar arches add to the height of many yacht types. Many in-port basin areas is only accessible under low bridges. This means lowering the arch is necessary.

Folding roofs and convertible tops are either rolled back (stowed) or moved forward/backward, serving more than one purpose and utilising the same space at least twice.

Apart from adding further luxury to the vessel, the benefits of using LINAK® actuators for all these applications are, that they are thoroughly tested to withstand life at sea, easy to integrate/install (only a few cables), and the fact that they are maintenance-free.

Folding roofs and radar arches

Raising and lowering radar arches for space optimisation, and folding roofs in/out for more comfort.



Actuators to create multi-function home below deck

Creating homely comfort on board recreational vessels is a prime goal of any yacht designer. The interior layout must embrace practical purposes and functions as well as offer convenience and exclusive luxury.

Easy raising and lowering of tables, or automatically turning two single beds into a master bed are some of the options that will add to the user experience. Apart from making life on board easier, movement solutions from LINAK® will also help get the most out of the space inside your yacht.



Small tables

Elevating tables into the ideal height for space optimisation and comfort.

When anchored or berthed comfort is key focus. Ventilating the cabins by opening windows and skylights, accessing remote stow room, lifting the TV set from the side panel or the wine rack from under the sole – basically,

anything requiring an extension or a retraction adjustment – can be controlled and smoothly performed by LINAK actuators.

From single bed to double bed

Automatically adjust single beds into double beds for improved usability and space utilisation.



Open hatches and convert stern to a bathing platform

Obviously, safety on board is paramount. With the right equipment a couple of practical features can appear in the shape of both extra comfort and increased safety.

Using LINAK® actuator solutions to lift hatches is an example. It is both convenient and a safety feature, as it locks, for example, the engine hatch securely when closed, as well as prevents it from falling when opened.

The same goes for adjustable bathing platforms. At first it seems like a pleasant luxury that you can turn the stern into an easy entry and exit for swim. However, it can also provide an invaluable rescue platform in case of crew in the water by accident.

Boat hatches

Opening and closing of hatches for easy access to e.g. the engine compartment or storage spaces





Windows

Automatically opening and closing windows or skylights for space optimisation and ventilation

Bathing platforms

Easily lowering or raising the bathing platform on a sailboat for direct and safe access to the water

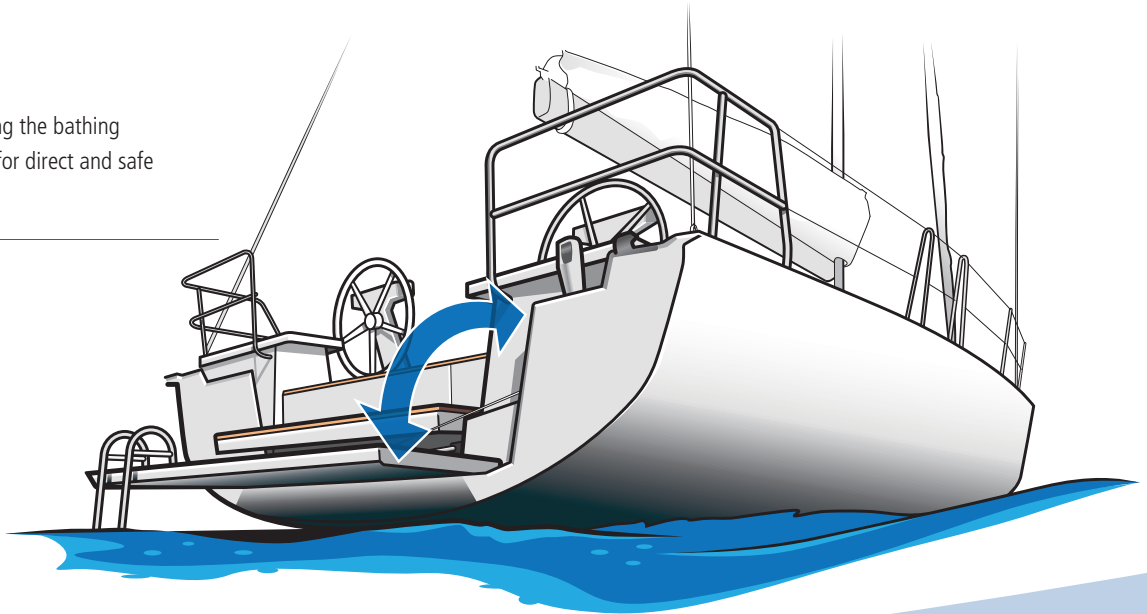

Explore the rich technology behind actuators



At the Actuator Academy™, you will find a library of videos and information about actuator components, actuator testing, and intelligent actuator control.

Find out what you should expect of a good industrial actuator, what affects its performance and efficiency, and how to best utilise your linear motion actuator.

We hope to inspire you and ultimately make you wiser on the moving electric revolution we are all part of.

Happy exploring!

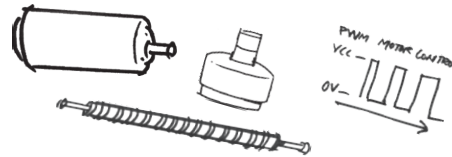
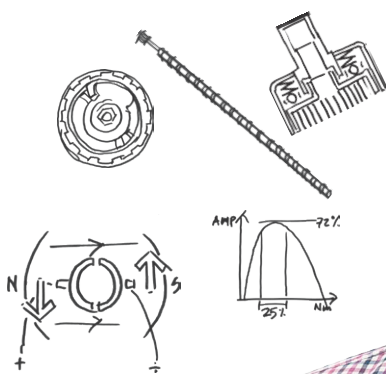

Check out the
Actuator Academy

[LINAK.COM/
ACTUATOR-ACADEMY](http://LINAK.COM/ACTUATOR-ACADEMY)

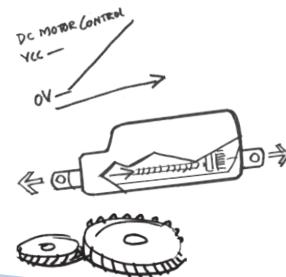

Smart movement for marine boats

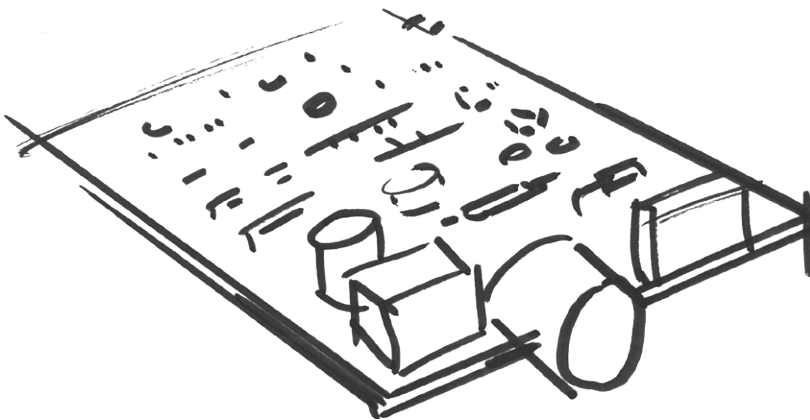

A LINAK® IC actuator with built-in controller reduces the number of external components and the need for a third-party supplier for power electronics.

It also offers a comprehensive range of interfaces and gives you access to productivity enhancing data - all delivered by a single supplier you can trust.

By helping you move smarter at every stage of your application process, from development, installation and integration to tailored movement and improved productivity, our IC actuators add value across the board.

IC INTEGRATED CONTROLLER™

Choosing an IC actuator for your application is a smart move in many ways:

- Reduced complexity for faster development and production
- Flexible integration with a variety of industrial interfaces
- Data monitoring that minimise downtime and boost productivity
- Benefit from one single supplier



For more information on IC, please visit LINAK.COM or scan the QR code.

Actuators for marine

LINAK® industrial actuators offer a versatile array of movement solutions for marine boats.

With **thrusts up to 15,000 N, max speeds up to 160 mm/s, and strokes between 20 and 999 mm**, the actuators are highly adaptable for a wide variety of applications.

Industrial actuators with **heavy-duty aluminium housings** are very suitable for use in corrosive environments. Having been thoroughly **salt spray and chemical resistance** tested and approved for ratings up to IP66 and IP69K static, these actuators will work reliably for years, even when exposed to salt, water, wind, and sun.

Operating temperatures between -40°C to +85°C make them fit for work in numerous settings. Also, they can be adapted to even harsher conditions with **stainless steel elements**.

Actuator LA37



Actuator LA36



Actuator LA33



Actuator LA25



Actuator LA14



Actuator LA12



Robust and powerful

LINAK® products are reliable products, made to last! High quality is the trademark of LINAK, and an element of the highest importance to us.

Increase durability with stainless steel options

For improved resistance against the harsh outdoor saltwater environments, LINAK® offers a selection of stainless steel piston rod eyes, back fixtures, and inner and outer tubes. This makes actuators even more resistant to the direct exposure of salt water and sun for years, which is particularly important around deck hatches or bathing platforms at the stern.

However, let us know what adjustment challenge you need to solve. It has never been easier to customise and integrate the right movement solution with modern yacht design.



Stainless steel back fixture
- AISI 304
- AISI 316*

Stainless steel piston rod eye - AISI 304

The actuator can be mounted with inner and outer tubes of stainless steel - AISI 304

*Only with LA36

Elegant lifting columns for smooth adjustment below deck

Elevating a table to the ideal dining height or extending a countertop to increase workspace are ideally done with LINAK® lifting columns. The same goes for raising, lowering, or reclining the captain's chair in order to provide a perfect view at the helm.

Apart from being low-noise, the LINAK lifting columns provide strong and reliable lift – both dynamic as well as static.

Lifting column BL1



Lifting column DL2



LC3 2-stage



LC3 3-stage



Testing programme

In each industrial application, the actuator is just one component of many, but at LINAK® we fully appreciate that it is of utmost importance to you and your customers. Not a single actuator leaves the factory until it has undergone a 100% function test.

Depending on the actuator type, various tests have been carried through. Please consult your local LINAK office or take a look at the actuator data sheet in question to get a thorough test overview.

This is your guarantee that a solution based on LINAK TECHLINE electric actuator systems is a solution that will work reliably for years and years.

“Our actuators must never malfunction. Therefore, it is important that all our products are tested inside and out, and to the extreme in a wide range of tests.”

- Claus H. Sørensen, Director R&D

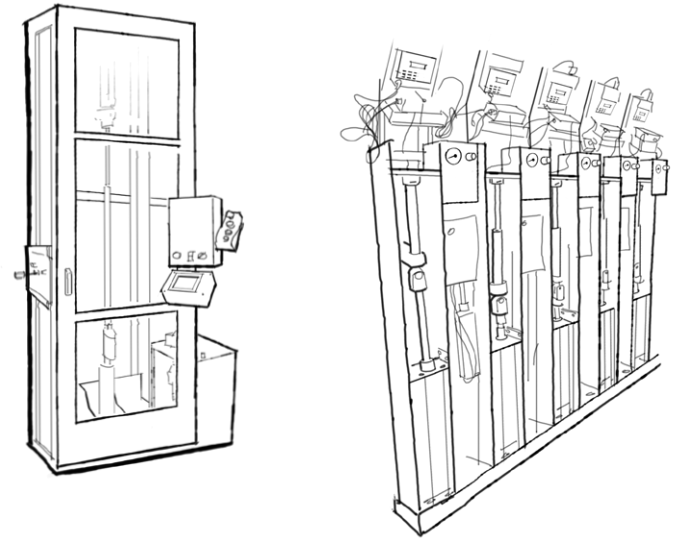

Climatic tests:

In the climatic test the actuators are tested to operate in extreme temperatures as well as to endure rapid changes in temperature. In a dunk test, the actuators have to withstand repeating temperature fluctuations between +85°C to -40°C and still maintain full functionality and ingress protection.

EN60529-IP6X	- Dust
EN60529-IPX6	- Water
ISO16750- IP69K	- High pressure cleaning
IEC60068-2-3	- Moisture storage
IEC60068-2-30	- Operation in moisture
ISO16750-4:2010	- Dunk test
EN60068-2-52	- Salt spray
BS7691 Section 6.11.2.4	- Chemicals

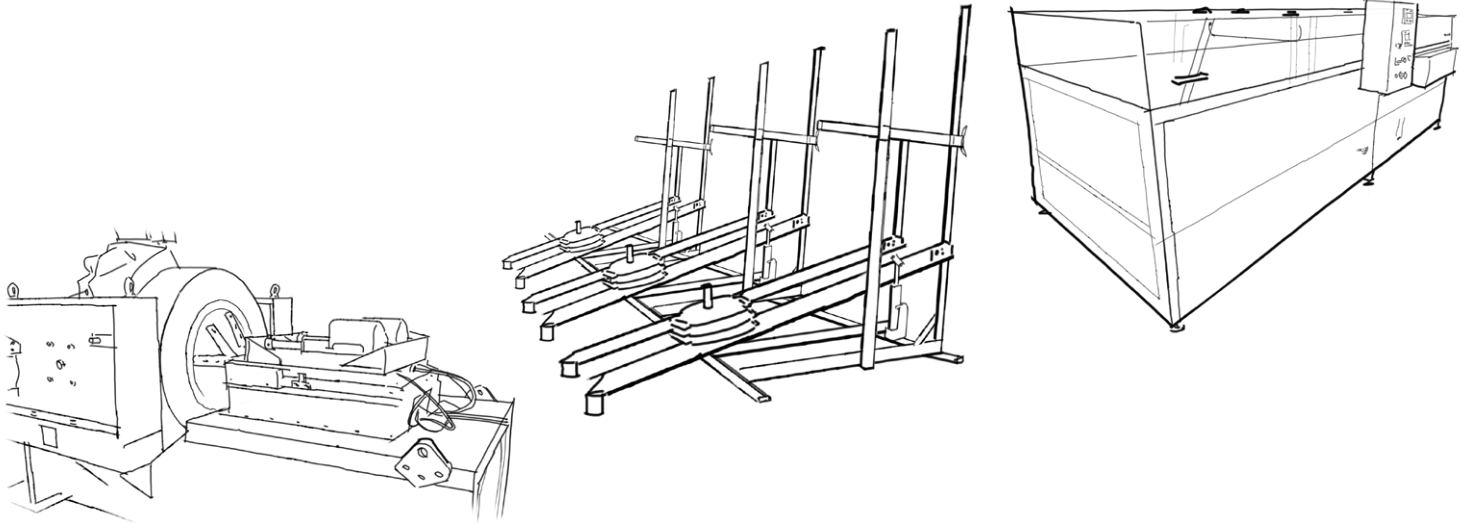

Electrical tests:

All electrical parts are tested i.e. power supply, power and signals cables, control signals etc. Electrical immunity is tested according to industrial standards i.e. for radio noise, electrical discharge and burst.*

EN/IEC 61000-6-4	- Generic standard emission industry
EN/IEC 60204	- Electrical equipment of machinery
EN 50121-3-2	- Railway applications - Rolling stock apparatus
94/25/EC	- Recreational crafts directive
EN/ISO 13766	- Earth moving machinery
EN/IEC 61000-6-2	- Generic standard immunity industry
2004/104/EC	- Automotive Directive
EN/ISO 14982	- Agricultural and forestry machines
EN/ISO 13309	- Construction machinery

* These tests do not apply to third party products!

Mechanical tests:

Vibration: The actuator must withstand continuous vibration in three directions.

Shock: The shock test puts the actuator through 3 shocks of up to 50 G in each of six directions.

Bump: The actuator receives bumps of up to 30 G in each of six directions several hundred times.

EN60068-2-64 (Fh) - Random vibration

EN60068-2-27 (Ea) - Shock

EN60068-2-29 (Eb) - Bump

Find out more about how we test actuators to the extreme:

linak.com/segments/techline/tech-trends/testing/





For further information, please visit our website:
LINAK.COM/BUSINESS-AREAS/MARINE/

LINAK® accepts no responsibility for possible errors or inaccuracies in catalogues, brochures, and other material. LINAK reserves the right to change its products without prior notice. LINAK cannot guarantee product availability and reserves the right to discontinue the sale of any product. User is responsible for determining the suitability of LINAK products for a specific application. All sales are subject to the 'Standard Terms of Sale and Delivery', available on LINAK websites.

LINAK and the LINAK logotype are registered trademarks of LINAK A/S. All rights reserved.



QUALITY

Built by market leading experts, using state-of-the-art technologies and perfected production methods, you can expect the same quality worldwide.



INNOVATION

Innovation is in our core. We take the lead and have the courage to make it real.



RESPONSIBILITY

We are responsible in what we do – towards customers, employees and environment. Creating trust is a natural part of who we are.



**LOCAL
& GLOBAL**

From global presence to local understanding. We believe in world-wide support and being close to our customers.