



Actuator LA35 User manual

Contents

Preface	4
LINAK application policy.....	5

Chapter 1

Safety instructions	6-7
---------------------------	-----

Chapter 2

Mounting guidelines.....	8-9
Mounting of cables	10
Electrical installation:.....	11
Recommended fuse.....	11
Actuator without feedback.....	12
<u>Actuator with:</u>	
Potential free endstop signal output.....	13
Relative positioning - Single Hall.....	14-15
Potential free endstop signals and relative positioning - Single Hall.....	16-17
Absolute positioning - Analogue feedback.....	18-19
Potential free endstop signals and absolute positioning - Analogue feedback.....	20-21
IC.....	22-24

Contents

Chapter 3

Troubleshooting	25-26
-----------------------	-------

Chapter 4

Specifications	27
Usage	27
Actuator dimensions.....	28
Speed and current curves:.....	29-30
12V motor	29
24V motor	30
Label for LA35	31
Key to symbols	32
LA35 Ordering example.....	33

Chapter 5

Maintenance.....	34
Repair	34
Main groups of disposal	34
Warranty	35
Declaration of conformity	36
Declaration of incorporation of partly completed machinery.....	37
Adresses	40

Preface

Dear User,

We are delighted that you have chosen a product from LINAK®.

LINAK systems are high-tech products based on many years of experience in the manufacture and development of actuators, electric control boxes, controls, and chargers.

This user manual does not address the end-user, but is intended as a source of information for the manufacturer of the equipment or system only, and it will tell you how to install, use and maintain your LINAK electronics. It is the responsibility of the manufacturer of the end-use product to provide a User Manual where relevant safety information from this manual is passed on to the end-user.

We are sure that your LINAK product/system will give you many years of problem-free operation. Before our products leave the factory they undergo full function and quality testing. Should you nevertheless experience problems with your LINAK product/system, you are always welcome to contact your local dealer. LINAK subsidiaries and some distributors situated all over the world have authorised service centres, which are always ready to help you.

LINAK provides a warranty on all its products. This warranty, however, is subject to correct use in accordance with the specifications, maintenance being done correctly and any repairs being carried out at a service centre, which is authorised to repair LINAK products.

Changes in installation and use of LINAK products/systems can affect their operation and durability. The products are not to be opened by unauthorised personnel.

The User Manual has been written based on our present technical knowledge. We are constantly working on updating the information and we therefore reserve the right to carry out technical modifications.

LINAK A/S

LINAK application policy

The purpose of the application policy is to define areas of responsibilities in relation to applying a LINAK product defined as hardware, software, technical advice, etc. related to an existing or a new customer application.

LINAK products as defined above are applicable for a wide range of applications within Medical, Furniture, Desk, and Industry areas. Yet, LINAK cannot know all the conditions under which LINAK products will be installed, used, and operated, as each individual application is unique.

The suitability and functionality of the LINAK product and its performance under varying conditions (application, vibration, load, humidity, temperature, frequency, etc.) can only be verified by testing, and shall ultimately be the responsibility of the LINAK customer using any LINAK product.

LINAK shall be responsible solely that LINAK products comply with the specifications set out by LINAK and it shall be the responsibility of the LINAK customer to ensure that the specific LINAK product can be used for the application in question.

Chapter 1



Safety instructions

Please read this safety information carefully:

Be aware of the following three symbols throughout the user manual:



Warning!

Failing to follow these instructions can cause accidents resulting in serious personal injury.



Recommendations

Failing to follow these instructions can result in the actuator suffering damage or being ruined.



Additional information

Usage tips or additional information that is important in connection with the use of the actuator.

Furthermore, ensure that all staff who are to connect, mount, or use the actuator are in possession of the necessary information and that they have access to this user manual.

Persons who do not have the necessary experience or knowledge of the product/products must not use the product/products. Besides, persons with reduced physical or mental abilities must not use the product/products, unless they are under surveillance or they have been thoroughly instructed in the use of the apparatus by a person who is responsible for the safety of these persons.

Moreover, children must be under surveillance to ensure that they do not play with the product.

Before you start mounting/dismounting, ensure that the following points are observed:

- The actuator is not in operation.
- The actuator is free from loads that could be released during this work.

Before you put the actuator into operation, check the following:

- The actuator is correctly mounted as indicated in the relevant user instructions.
- The equipment can be freely moved over the actuator's whole working area.
- The actuator is connected to a mains electricity supply/transformer with the correct voltage and which is dimensioned and adapted to the actuator in question.
- Ensure that the voltage applied matches to the voltage specified on the actuator label.
- Ensure that the connection bolts can withstand the wear.
- Ensure that the connection bolts are secured safely.

During operation, please be aware of the following:

- Listen for unusual sounds and watch out for uneven running. Stop the actuator immediately if anything unusual is observed.
- Do not sideload the actuator.
- Only use the actuator within the specified working limits.
- Do not step or kick on the actuator.

When the equipment is not in use:

- Switch off the mains supply in order to prevent unintentional operation.
- Check regularly for extraordinary wear.

Classification

The equipment is not suitable for use in the presence of a flammable anaesthetic mixture with air or with oxygen or nitrous oxide.



Warnings

- Do not sideload the actuator.
- When mounting the LA35 in the application ensure that the bolts can withstand the wear and that they are secured safely.
- If irregularities are observed, the actuator must be replaced.



Recommendations

- Do not place load on the actuator housing and do prevent impact or blows, or any other form of stress to the housing.
- Ensure that the cable cover is mounted correctly. Use 3.5Nm torque.
- Ensure that the duty cycle and the usage temperatures for LA35 actuators are respected.
- Ensure that the cable cannot be squeezed, pulled or subjected to any other stress.
- Furthermore, it will be good practice to ensure that the actuator is fully retracted in the "normal" position. The reason is that there will be a vacuum inside the actuator if it is extended which over time can lead to water entering the actuator.
- If the actuator (without integrated controller) is mounted in an application where a mechanical stop prevents the endstop switches in the actuator from being activated, the actuator must be equipped with an electrical safety device (current monitoring) or external limit switch.

Chapter 2

Mounting guidelines

LINAK® linear actuators are quickly and easily mounted by slipping pins through the holes on each end of the units and into brackets on the machine frame and the load.

The mounting pins must be parallel to each other as shown in Figure 1. Pins, which are not parallel to each other, may cause the actuator to bend and be damaged.

The load should act along the stroke axis of the actuator as off-centre loads may cause bending and lead to premature failure. See Figure 2.

Make sure the mounting pins are supported in both ends. Failure to do so could shorten the life of the actuator. Also, avoid applying a skew load on the actuator.

Figure 1

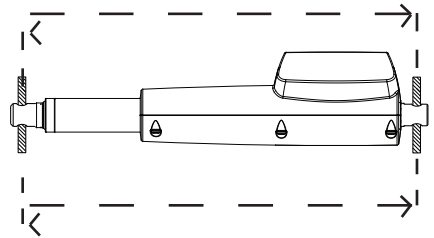

The actuator can rotate around the pivot point in the front and rear end. If this is the case it is of high importance that the actuator is able to move freely over the full stroke length, both during the development and daily operation. Please pay special attention to the area around the housing where parts can be trapped and cause damage to the application and actuator.

In applications with high dynamic forces LINAK recommends not to use the fully extended or retracted position over long time, as this can damage the endstop system permanently.

Figure 2

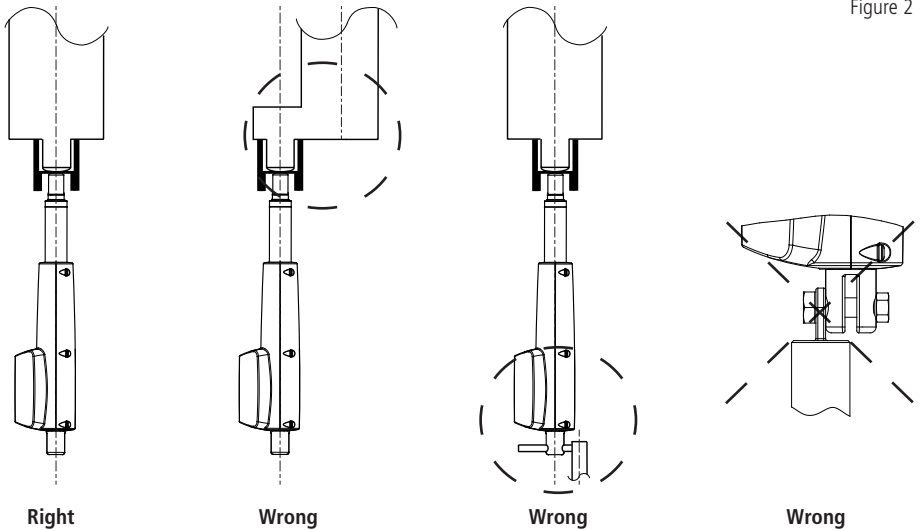

Please be aware that if the LA35 is used for solar applications the actuator must be mounted with the motor housing turned upwards and the wires pointing downwards.

Mounting guidelines



- The mounting pins must have the correct dimension.
- The bolts and nuts must be made of a high quality steel grade (e.g. 10.8). No thread on the bolt inside the back fixture or the piston rod eye.
- Bolts and nuts must be protected so there is no risk for them to fall out.
- Do not use a torque that is too high when mounting the bolts for the back fixture or the piston rod eye. This will stress the fixtures.



Please note:

The piston rod eye is only allowed to turn 0-90 degrees.



Instruction concerning the turning of the piston rod eye and inner tube:

- When mounting and taking into use, it is not permitted to make excessive turns of the piston rod eye. In cases where the eye is not positioned correctly, it is permitted to first screw the eye down to its bottom position, at a maximum torque of 2Nm (1), and thereafter a maximum 90 degrees turn outwards again (2).
- As the piston rod eye can turn freely, it is important to ensure that the eye cannot rotate if the actuator is used in a pull application. If this happens, the actuator will be pulled apart and destroyed.

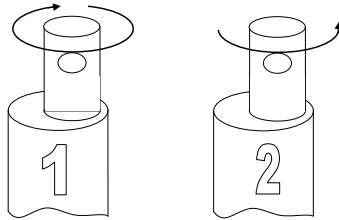

Warning!

If the actuator is used for pull in an application where personal injury can occur, the following is valid:

It is the application manufacturer's responsibility to incorporate a suitable safety arrangement, which will prevent personal injury from occurring, if the actuator should fail.



Warning!

LINAK's actuators are not designed for use within the following fields:

- Offshore installations
- Explosive environments
- Aeroplanes and other aircraft
- Nuclear power generation

Mounting of cables



1. Unscrew the cover and remove the two cables and/or blind plugs.

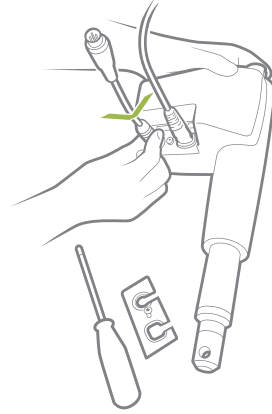

2. Plug in the power cable and/or the signal cable.

3. Slide the cover onto the actuator.

The torque of the cover screw is approx. 3.5 ± 0.2 Nm

TORX 25IP

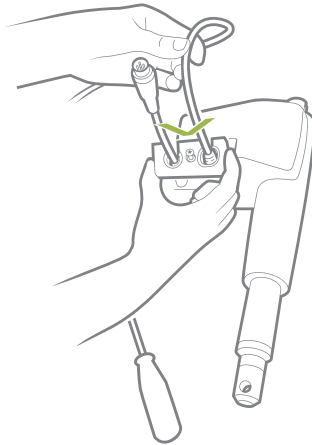

When changing the cables on a LINAK actuator, it is important that this is done carefully, in order to protect the plugs and pins. Before the new cable is mounted, we recommend that the socket is greased with vaseline, to keep the high IP protection and ensure an easy mounting. Please be sure that the plug is in the right location and fully pressed in before the cable lid is mounted.

Please note that if the cables are mounted and dismantled more than 3 times the plugs can be damaged. Therefore, we recommend that such cables are discarded and replaced.

Also note that the cables should not be used for carrying the actuator.

We recommend to take some precaution and design the wire connection in a way, where the cable end is kept inside a closed, protected area to guarantee the high IP protection.

Electrical installation



- To ensure maximum self-locking ability, please be sure that the motor is shorted when stopped. Actuators with integrated controller provide this feature, as long as the actuator is powered.
- When using soft stop on a DC-motor, a short peak of higher voltage will be sent back towards the power supply. It is important when selecting the power supply that it does not turn off the output, when this backwards load dump occurs.



The power supply for actuators without integrated controller must be monitored externally and cut off in case of current overload.

Recommended fuse for actuators without integrated controller

Type	Spindle Pitch (mm)	Thrust max. Push/Pull (N)	Typical Amp. at full load (A)		Recommended fuse	
			24V	12V	24V	12V
3510xx...	3	6000 / 4000	4.2	7.5	8.4	15.0
3520xx...	5	4000	4.8	7.7	9.6	15.4
3521xx... push brake	5	4000	4.3	7.8	8.6	15.6
3522xx... pull brake	5	4000	4.6	8.4	9.2	16.8
3530xx...	9	1500	2.6	5.9	5.2	11.8
3531xx... push brake	9	1500	2.9	5.5	5.8	11.0
3532xx... pull brake	9	1500	3.0	5.4	6.0	10.8
3540xx...	12	1000	2.8	5.3	5.6	10.6
3541xx... push brake	12	1000	2.8	5.5	5.6	11.0
3542xx... pull brake	12	1000	2.9	5.6	5.8	11.2

Actuator without feedback

Connection diagram:

Fig. 1 : 35xxxxx00xxxxxx

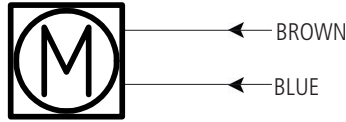

I/O specifications:

Input/Output	Specification	Comments
Description	Permanent magnetic DC motor. See connection diagram, fig. 1 above	
Brown	12 or 24VDC (+/-) 12V ± 20% 24V ± 10%	To extend actuator: Connect Brown to positive
Blue	Under normal conditions: 12V, max. 10A depending on load 24V, max. 5A depending on load	To retract actuator: Connect Brown to negative
Red	Not to be connected	To extend actuator: Connect Blue to negative
Black	Not to be connected	To retract actuator: Connect Blue to positive
Green	Not to be connected	
Yellow	Not to be connected	
Violet	Not to be connected	
White	Not to be connected	

Actuator with potential free endstop signal output

Connection diagram:

Fig. 2 : 35xxxxx10xxxxxx

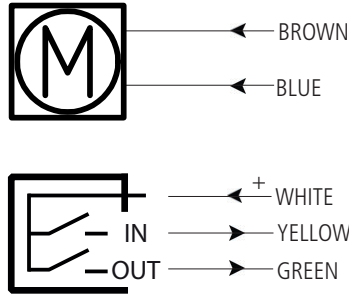

I/O specifications:

Input/Output	Specification	Comments
Description	The actuator is equipped with potential free endstop signals out. The micro switches are normally open. See connection diagram, fig. 2 above	
Brown	12 or 24VDC (+/-) 12V ± 20% 24V ± 10%	To extend actuator: Connect Brown to positive To retract actuator: Connect Brown to negative
Blue	Under normal conditions: 12V, max. 10A depending on load 24V, max. 5A depending on load	To extend actuator: Connect Blue to negative To retract actuator: Connect Blue to positive
White	Potential free signal power supply (+) 10-28VDC	Switching capacity: Minimum 10mA Maximum 1A
Black	Not to be connected	
Green	Endstop signal out	Output voltage is the same as the input voltage
Yellow	Endstop signal in	
Violet	Not to be connected	
Red	Not to be connected	

Actuator with relative positioning - Single Hall

Connection diagram:

Fig. 3 : 35xxxxx0Hxxxxxx

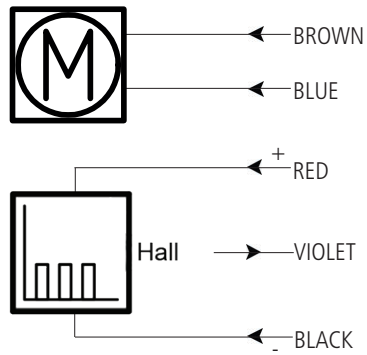

Actuator with relative positioning - Single Hall

I/O specifications:

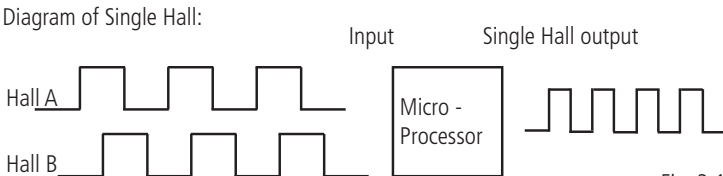
Input/Output	Specification	Comments
Description	The actuator is equipped with Single Hall that gives a relative positioning feedback signal when the actuator moves. See connection diagram, fig. 3, page 15	
Brown	12-24VDC (+/-) 12V ± 20% 24V ± 10%	To extend actuator: Connect Brown to positive To retract actuator: Connect Brown to negative
Blue	Under normal conditions: 12V, max. 10A depending on load 24V, max. 5A depending on load	To extend actuator: Connect Blue to negative To retract actuator: Connect Blue to positive
Red	Signal power supply (+) 10-28VDC	Current consumption: Max. 40mA, also when the actuator is not running
Black	Signal power supply GND (-)	
Green	Not to be connected	
Yellow	Not to be connected	
Violet	Single Hall output (PNP) Movement per single Hall pulse: 3mm pitch = 0.38mm per pulse 5mm pitch = 0.63mm per pulse 9mm pitch = 1.13mm per pulse 12mm pitch = 1.5mm per pulse Frequency: Frequency is 30-125 Hz on Single Hall output depending on load. Every pulse is "ON" for minimum 3ms. Overvoltage on the motor can result in shorter pulses.	Output voltage min. $V_{IN} - 2V$ Max. current output: 12mA Max. 680nF N.B. For more precise measurements, please contact LINAK A/S. Low frequency with a high load. Higher frequency with no load.
	Diagram of Single Hall: 	Fig. 3.1
White	Not to be connected	

Actuator with potential free endstop signals and relative positioning - Single Hall

Connection diagram:

Fig. 4 : 35xxxxx1Hxxxxxx

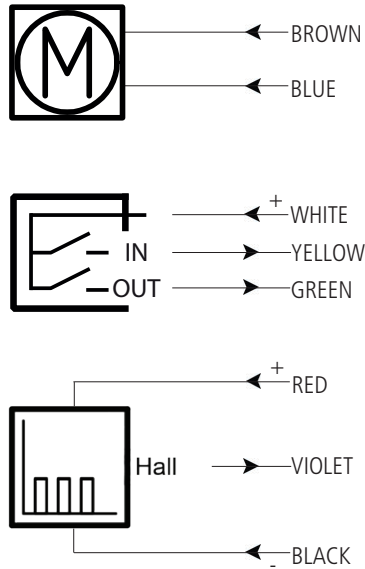

Actuator with potential free endstop signals and relative positioning - Single Hall

I/O specifications:

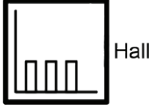
Input/Output	Specification	Comments
Description	<p>The actuator is equipped with potential free endstop signals and Single Hall that gives a relative positioning feedback signal when the actuator moves.</p> <p>See connection diagram, fig. 4, page 17</p>	
Brown	<p>12-24VDC (+/-)</p> <p>12V \pm 20%</p> <p>24V \pm 10%</p>	<p>To extend actuator: Connect Brown to positive</p> <p>To retract actuator: Connect Brown to negative</p>
Blue	<p>Under normal conditions: 12V, max. 10A depending on load 24V, max. 5A depending on load</p>	<p>To extend actuator: Connect Blue to negative</p> <p>To retract actuator: Connect Blue to positive</p>
Red	Signal power supply (+) 10-28VDC	Current consumption: Max. 40mA, also when the actuator is not running
Black	Signal power supply GND (-)	
Green	Endstop signal out	Output voltage min. $V_{IN} - 2V$ Source current max. 100mA NOT potential free
Yellow	Endstop signal in	
Violet	<p>Single Hall output (PNP)</p> <p>Movement per Single Hall pulse: 3mm pitch = 0.38mm per pulse 5mm pitch = 0.63mm per pulse 9mm pitch = 1.13mm per pulse 12mm pitch = 1.5mm per pulse</p> <p>Frequency: Frequency is 30-125 Hz on Single Hall output depending on load and spindle. Overvoltage on the motor can result in shorter pulses.</p>	<p>Output voltage min. $V_{IN} - 2V$ Max. current output: 12mA Max. 680nF</p> <p>N.B. For more precise measurements, please contact LINAK A/S.</p> <p>Low frequency with a high load. Higher frequency with no load.</p>
White	Potential free signal power supply (+) 10-28VDC	Switching capacity: Minimum 10mA Maximum 1A

Actuator with absolute positioning - Analogue feedback

Connection diagram:

Fig. 5 : 35xxxxx0xxxxxxx

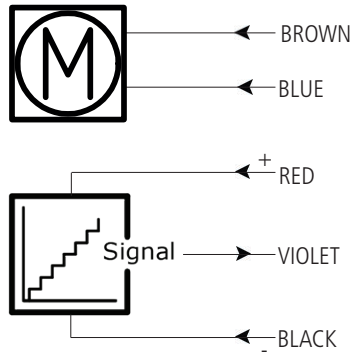

Actuator with absolute positioning - Analogue feedback

I/O specifications:

Input/Output	Specification	Comments
Description	The actuator is equipped with electronic circuit that gives an analogue feedback signal when the actuator moves. See connection diagram, fig. 5, page 19	
Brown	12-24VDC (+/-) 12V \pm 20% 24V \pm 10%	To extend actuator: Connect Brown to positive To retract actuator: Connect Brown to negative
Blue	Under normal conditions: 12V, max. 10A depending on load 24V, max. 5A depending on load	To extend actuator: Connect Blue to negative To retract actuator: Connect Blue to positive
Red	Signal power supply (+) 10-28VDC	Current consumption: Max. 40mA, also when the actuator is not running
Black	Signal power supply GND (-)	
Green	Not to be connected	
Yellow	Not to be connected	
Violet	Analogue feedback 0-10V (Option A) 0.5-4.5V (Option B)	Tolerances +/- 0.5V Max. current output: 1mA Ripple max. 200mV Transaction delay 100ms Linear feedback 0.5% It is recommendable to have the actuator to activate its limit switches on a regular basis, to ensure more precise positioning
White	Not to be connected	

Actuator with potential free endstop signals and absolute positioning - Analogue feedback

Connection diagram:

Fig. 6 : 35xxxxx1xxxxxx

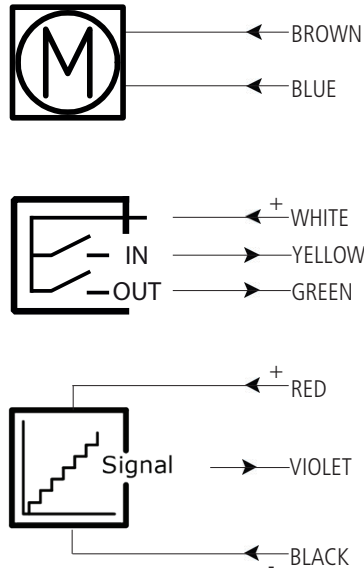

Actuator with potential free endstop signals and absolute positioning - Analogue feedback

I/O specifications:

Input/Output	Specification	Comments
Description	<p>The actuator is equipped with potential free endstop signals and an electronic circuit that gives an analogue feedback signal when the actuator moves.</p> <p>See connection diagram, fig. 6, page 21</p>	
Brown	<p>12-24VDC (+/-)</p> <p>12V ± 20%</p> <p>24V ± 10%</p>	<p>To extend actuator: Connect Brown to positive</p> <p>To retract actuator: Connect Brown to negative</p>
Blue	<p>Under normal conditions: 12V, max. 10A depending on load 24V, max. 5A depending on load</p>	<p>To extend actuator: Connect Blue to negative</p> <p>To retract actuator: Connect Blue to positive</p>
Red	<p>Signal power supply (+) 10-28VDC</p>	<p>Current consumption: Max. 40mA, also when the actuator is not running</p>
Black	<p>Signal power supply GND (-)</p>	
Green	<p>Endstop signal out</p>	<p>Output voltage is the same as the input voltage</p>
Yellow	<p>Endstop signal in</p>	
Violet	<p>Analogue feedback</p> <p>0-10V (Option A) 0.5-4.5V (Option B)</p>	<p>Tolerances +/- 0.5V Max. current output: 1mA Ripple max. 200mV Transaction delay 100ms Linear feedback 0.5%</p> <p>It is recommendable to have the actuator to activate its limit switches on a regular basis, to ensure more precise positioning</p>
White	<p>Potential free signal power supply (+) 10-28VDC</p>	<p>Switching capacity: Minimum 10mA Maximum 1A</p>

Actuator with IC

Connection diagram:

Fig. 7 : 35xxxxx2xxxxxx

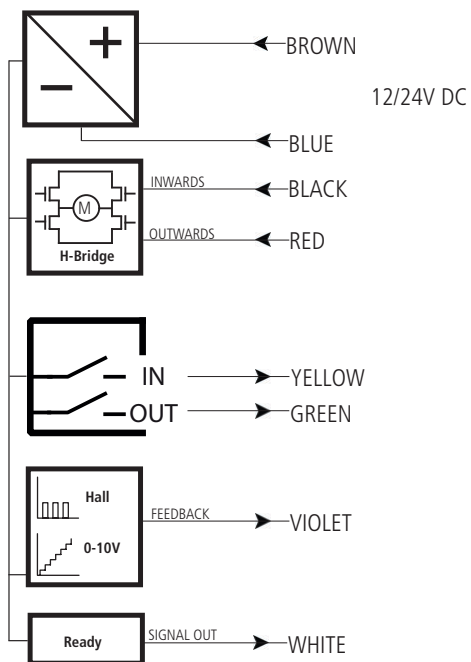

Please be aware that if the power supply is not properly connected, you might damage the actuator!

Actuator with IC

I/O specifications:

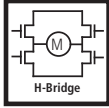
Input/Output	Specification	Comments
Description	<p>Easy to use interface with integrated power electronics (H-bridge). The actuator can also be equipped with electronic circuit that gives an absolute or relative feedback signal.</p> <p>The version with "IC option" cannot be operated with PWM (power supply). See connection diagram, fig. 7, page 23</p>	 <p>The diagram shows a square H-bridge circuit with a motor symbol (M) in the center. The bridge has four input terminals on the left and four output terminals on the right. The text "H-Bridge" is written below the diagram.</p>
Brown	<p>12-24VDC + (VCC) Connect Brown to positive</p> <p>12V ± 20% 24V ± 10%</p> <p>12V, current limit 18A 24V, current limit 9A</p>	<p>Note: Do not change the power supply polarity on the brown and blue wires!</p> <p>Power supply GND (-) is electrically connected to the housing</p>
Blue	<p>12-24VD - (GND) Connect Blue to negative</p> <p>12V ± 20% 24V ± 10%</p> <p>12V, current limit 18A 24V, current limit 9A</p>	<p>If the temperature drops below 0°C, all current limits will automatically increase to maximum (no limits)</p>
Red	Extends the actuator	On/off voltages:
Black	Retracts the actuator	<p>> 67% of V_{IN} = ON < 33% of V_{IN} = OFF</p> <p>Input current: 10mA</p>
Green	Endstop signal out	Output voltage min. $V_{IN} - 2V$
Yellow	Endstop signal in	<p>Source current max. 100mA</p> <p>Endstop signals are NOT potential free.</p>

Actuator with IC

I/O specifications:

Input/Output	Specification	Comments
Violet	Analogue feedback: Configure any high/low combination between 0-10V or 0.5-4.5V 0-10V (Option A) 0.5-4.5V (Option B)	Tolerances +/- 0.5V Max. current output: 1mA Ripple max. 200mV Transaction delay 100ms Linear feedback 0.5% It is recommendable to have the actuator to activate its limit switches on a regular basis, to ensure more precise positioning
	Single Hall output (PNP) Movement per Single Hall pulse: 3mm pitch = 0.38mm per pulse 5mm pitch = 0.63mm per pulse 9mm pitch = 1.13mm per pulse 12mm pitch = 1.5mm per pulse Frequency: Frequency is 30-125 Hz on Single Hall output depending on load and spindle. Overvoltage on the motor can result in shorter pulses.	Output voltage min. $V_{IN} - 2V$ Max. current output: 12mA Max. 680nF N.B. For more precise measurements, please contact LINAK A/S. Low frequency with a high load. Higher frequency with no load.
White	Ready	The signal is constantly high when the actuator is in ready mode. Failure modes: The signal goes low when: - The current cuts off - The temperature is out of range (high duty cycle protection)



The high duty cycle protection is NOT to be used as a stop function, since this might damage the actuator!

Chapter 3

Troubleshooting

Symptom	Possible cause	Action
Motor runs but spindle does not move	Gearing system or spindle damaged	Please contact LINAK
No motor sound or movement of piston rod	The actuator is not properly connected to the power supply	Check the connection to the power supply or the external control unit (if any)
	Customer fuse burned	Check the fuse
	Cable damaged	Change the cable
	For IC only: Wrongly connected	For IC only: Please make sure that the power supply polarity is properly connected, otherwise you might damage the actuator Check the wire connection on the internal control unit
Excessive power consumption	Misalignment or overload in the application	Align or reduce the load
		Try to run the actuator without load
Actuator cannot lift full load or motor runs too slowly	Misalignment or overload in the application	Align or reduce the load
		Try to run the actuator without load
	Insufficient power supply	Check the power supply

Troubleshooting

Symptom	Possible cause	Action
No signal or incorrect feedback output	Cable damaged	Change the cable
	Wrongly connected	Check the wiring
	Signal is constantly high/low	Run the actuator to fully extended and retracted positions
	Feedback output overloaded	Reduce the load according to your chosen feedback type
Actuator runs in smaller steps	Insufficient power supply	Check the power supply
	Load is higher than specified	Reduce the load
Actuator cannot hold the chosen load	Load is higher than specified	Reduce the load



For further assistance, please contact your local LINAK supplier.

Chapter 4

Specifications

Motor:	Permanent magnet motor 12 or 24V *
Cable:	Motor: 2 x 14 AWG PVC cable Control: 6 x 20 AWG PVC cable **
Housing:	The housing is made of casted aluminium, coated for outdoor use and in harsh conditions
Spindle part:	Outer tube: Powder coated steel Inner tube: Stainless steel AISI304/SS2333 Acme spindle: Trapezoidal spindle with high efficiency
Temperature range:	-25° C to +60° C -13° F to +140° F Full performance +5° C to +40° C
End play:	2 mm maximum
Weather protection:	Rated IP66 for outdoor use. Furthermore, the actuator can be washed down with a high-pressure cleaner (IP69K)
Compatibility:	The LA35 IC is compatible with SMPS-T160 (For combination possibilities, please see the User Manual for SMPS-T160)

Usage:

- Duty cycle at 6000N and 3mm pitch is max. 10%
- Noise level: 48 dB (A) measuring method DS/EN ISO 3743-1 actuator not loaded

- **Safety device regarding functional failure:**

Safety nut

The LA35 has a built-in safety nut in push as an option. Actuators with safety nut in push can only function when used in push applications. The safety nut comes into operation should the main nut fail. Afterwards it is only possible to drive the actuator into the innermost position. Thereafter, the actuator will not function any more and must be sent for service

Mechanical endstop

LA35 is equipped with mechanical endstop

* Modbus actuators only 24V - please see the Modbus installation guide:

<https://cdn.linak.com/-/media/files/ic-and-bus-actuators/techline-modbus-installation-guide-eng.ashx?la=en>

** Special control cables for the Modbus actuator - please see the Modbus installation guide:

<https://cdn.linak.com/-/media/files/ic-and-bus-actuators/techline-modbus-installation-guide-eng.ashx?la=en>

Actuator dimensions

TECHLINE® LA35:

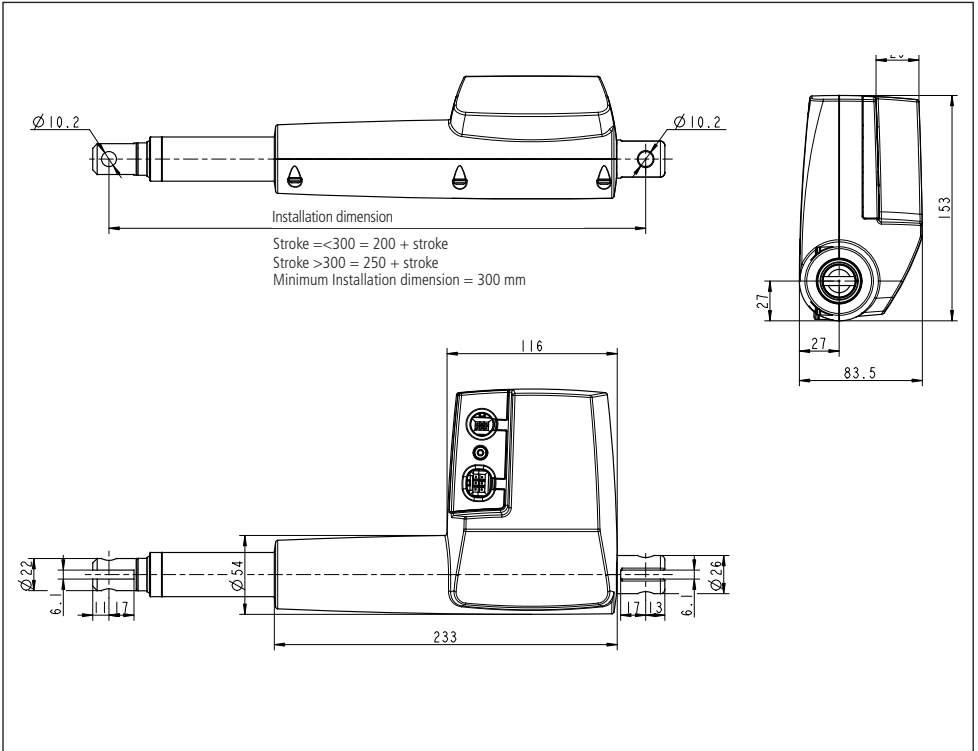

Speed and current curves - 12V motor

The values below are typical values and made with a stable power supply and an ambient temperature of 20°C.

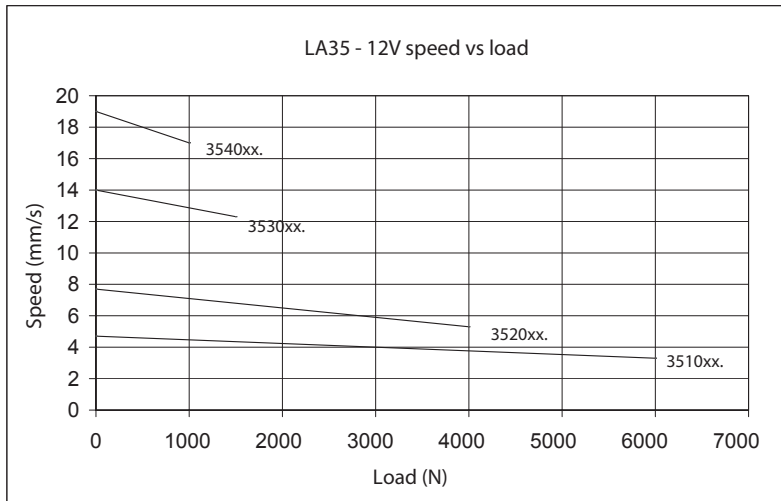
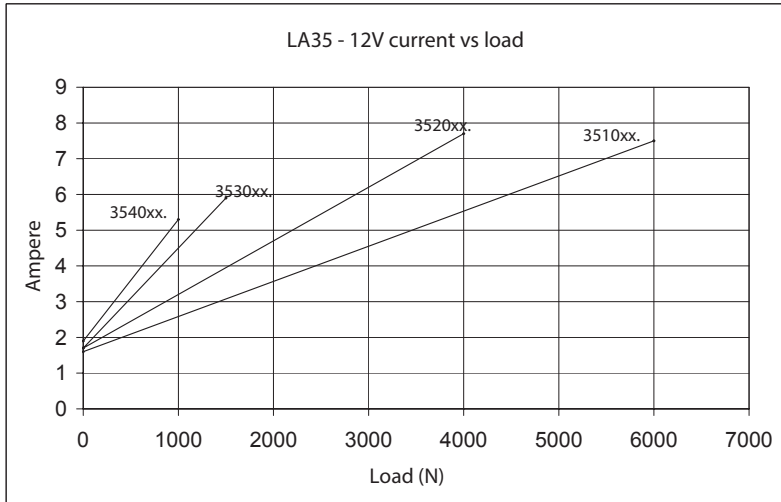

Speed and current curves - 24V motor

The values below are typical values and made with a stable power supply and an ambient temperature of 20°C.

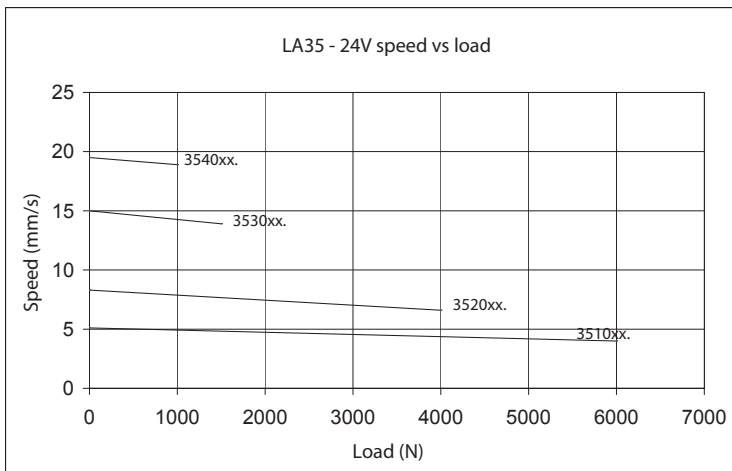
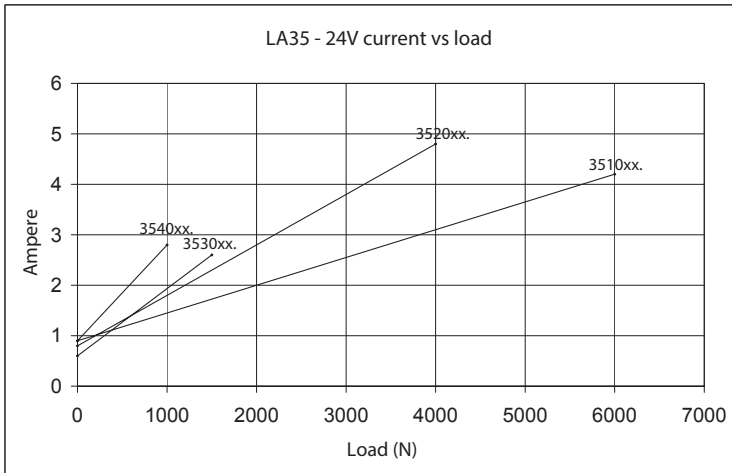





Label for LA35



WE IMPROVE YOUR LIFE
DESIGNED IN DENMARK
Item No. : 3540A1+00200B21
Prod. Date : 2016.01.12
Max Load : Push 1000 N / Pull 1000 N IP66
Power Rate: 24V = / Max. 3.1 A
Duty Cycle : 10%, Max. 2 min./18 min

 NOT TO BE OPENED BY UNAUTHORIZED PERSONNEL
NE PAS OUVRIR PAR DU PERSONNEL NON AUTORISE

W/O #1234567-0001 MADE BY LINAK A/S DENMARK

1. Type: 3540A1+00200B21

Describes the basic functionality of the product

2. Prod. Date: YYYY.MM.DD

Production date describes when the product has been produced. This date is the reference for warranty claims

3. Max Load: Push 1000N / Pull 1000N IP66

Describes the maximum load that the product can be exposed to in compression and tension.
This line also contains a reference to the product's IP protection degree

4. Power Rate: 24VDC / Max. 3.1 Amp

Input voltage for the product and maximum current consumption

5. Duty Cycle: 10%, Max. 2 min. / 18 min.







The duty cycle defines the maximum period during operation without interruption. After operation, a pause must be observed. It is important that the operator follows the instructions of the duty cycle; otherwise, a possible overload may result in reduced product life/errors

6. W/O #1234567-0001

The LINAK work order followed by a unique sequential identification number

Key to symbols

The following symbols are used on the LA35 label:

Symbol	Norms	Approvals
	WEEE Directive 2002/96/EC	Wheellie bin
	Compliance to all relevant EC directives	CE
	Regulatory Compliance Mark: The Australian safety/EMC regulations	RCM
	China Pollution control mark (also indicates recyclability)	China RoHS legislation
	ISO 7000- 0434A: Caution	
	Operating instructions	

LA35 ordering example

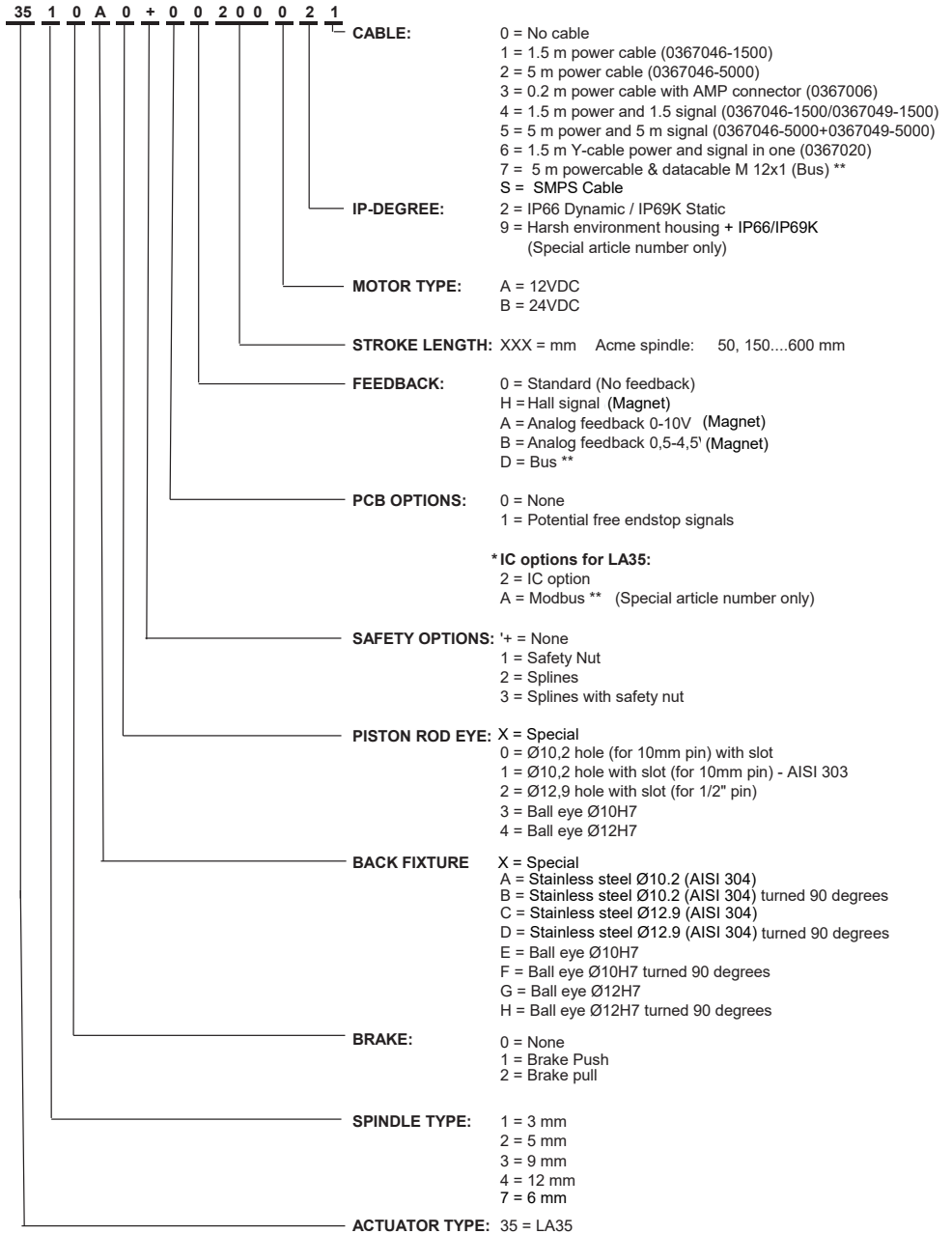

IC options:	Basic IC	Modbus
LA35 actuator:	<input type="checkbox"/>	<input type="checkbox"/>

** Cables option 7, Feedback option D and PCB option A are connected and can only be configured with Motor Type B

Chapter 5

Maintenance

- The actuator must be cleaned at regular intervals to remove dust and dirt and inspected for mechanical damages or wear.
- Inspect attachment points, wires, piston rod, cabinet, and plug, as well as check that the actuator functions correctly.
- To ensure that the pregreased inner tube remains lubricated, the actuator must only be washed down when the piston rod is fully retracted.
- The actuator is a closed unit and therefore requires no internal maintenance.
- In order to maintain a proper performance of the spherical eyes and to increase the resistance against environmental wear, we strongly recommend that the spherical eyes (ball bearings) mounted on actuators from LINAK are greased with anticorrosive grease or similar.

Repair

Only an authorised LINAK® service centre should repair LINAK actuator systems. Systems to be repaired under warranty must be sent to an authorised LINAK service centre.

In order to avoid the risk of malfunction, all actuator repairs must only be carried out by an authorised LINAK Service shop or repairer, as special tools and parts must be used.

If a system is opened by unauthorised personel there is a risk that it may malfunction at a later date.

Main groups of disposal

LINAK's products may be disposed of, possibly by dividing them into different waste groups for recycling or combustion.

Product	Metal scrap	Cable scrap	Electronic scrap	Plastic recycling or combustion
LA35	X	X	X	X

We recommend that our product is disassembled as much as possible at the disposal and that you try to recycle it.

Warranty

There is an 18 months' warranty on TECHLINE products against manufacturing faults calculated from the production date of the individual products (see label). LINAK's warranty is only valid in so far as the equipment has been used and maintained correctly and has not been tampered with. Furthermore, the actuator must not be exposed to violent treatment. In the event of this, the warranty will be ineffective/invalid. For further details, please see standard terms of sale and delivery for LINAK A/S.

Note:

Only an authorised LINAK® service centre should repair LINAK actuator systems. Systems to be repaired under warranty must be sent to an authorised LINAK service centre.

In order to avoid the risk of malfunction, all actuator repairs must only be carried out by an authorised LINAK Service shop or repairer, as special tools and parts must be used.

If a system is opened by unauthorised personnel there is a risk that it may malfunction at a later date.

The actuator is not to be opened by unauthorised personnel. In case the actuator is opened, the warranty will be invalid.



DECLARATION OF CONFORMITY

LINAK A/S
Smedevænget 8
DK - 6430 Nordborg

Hereby declares that LINAK Actuator 35xxxxxxxxxx2x

complies with the EMC Directive 2014/30/EU according to following harmonized standards:

EN 61000-4-2:2009, EN 61000-4-3:2006+A1+A2, EN 61000-4-4:2012, EN 61000-4-5:2014, EN 61000-4-6:2014,
EN 50121-3-2: 2015, EN 60204-31: 2013

complies with RoHS2 Directive 2011/65/EU according to the standard:
EN 50581:2012

Additional information:

The actuator does also comply with EMC requirements of:

The Machinery Directive 2006/42/EC

The Recreational Craft Directive 94/25/EC

The Vehicle EMC Directive 2004/104/EC

and the following standards:

DS/EN 13309:2001 (Construction machinery - Electromagnetic compatibility of machines with internal electrical power supply),

DS/EN ISO 14982:1998 (Agricultural and forestry machines - Electromagnetic compatibility - Test methods and acceptance criteria),

EN/ISO 13766:2006 (Earth-moving machinery - Electromagnetic compatibility)

Nordborg, 2015-11-04



LINAK A/S

John Kling, B.Sc.E.E.

Certification and Regulatory Affairs

Authorized to compile the relevant technical documentation

Original declaration

DECLARATION OF INCORPORATION OF PARTLY COMPLETED MACHINERY

LINAK A/S
Smedevænget 8
DK - 6430 Nordborg

Herewith declares that LINAK TECHLINE ® products
as characterized by the following models and types:

Linear Actuators LA12, LA14, LA22, LA23, LA25, LA30, LA35, LA36, LA37

comply with the following parts of the Machinery Directive 2006/42/EC, ANNEX I, *Essential health and safety requirements relating to the design and construction of machinery*:

1.5.1 Electricity supply

The relevant technical documentation is compiled in accordance with part B of Annex VII and that this documentation or part hereof will be transmitted by post or electronically to a reasoned request by the national authorities.

This partly completed machinery must not be put into service until the final machinery into which it is to be incorporated has been declared in conformity with the provisions of the Machinery Directive 2006/42/EC where appropriate.

Nordborg, 2014-10-20



LINAK A/S
John Kling, B.Sc.E.E.
Certification and Regulatory Affairs
Authorized to compile the relevant technical documentation

Original Declaration

FACTORIES

China

LINAK (Shenzhen) Actuator Systems, Ltd.
Phone: +86 755 8610 6656
Phone: +86 755 8610 6990
www.linak.cn

Denmark - Headquarters

LINAK A/S
Phone: +45 73 15 15 15
Fax: +45 74 45 80 48
Fax (Sales): +45 73 15 16 13
www.linak.com

Slovakia

LINAK Slovakia s.r.o.
Phone: +421 51 7563 444
www.linak.sk

Thailand

LINAK APAC Ltd.
Phone: +66 33 265 400
www.linak.com

USA

LINAK U.S. Inc.
Americas Headquarters
Phone: +1 502 253 5595
Fax: +1 502 253 5596
www.linak-us.com
www.linak-latinamerica.com

SUBSIDIARIES

Australia

LINAK Australia Pty. Ltd
Phone: +61 3 8796 9777
Fax: +61 3 8796 9778
www.linak.com.au

Austria

LINAK Repräsentanz - Österreich (Wien)
Phone: +43 (1) 890 7446
Fax: +43 (1) 890 744615
www.linak.at - www.linak.hu

Belgium

LINAK Actuator-Systems NV/SA
(Belgium & Luxembourg)
Phone: +32 (0)9 230 01 09
www.linak.be - www.fr.linak.be

Brazil

LINAK Do Brasil Comércio De Atuadores Ltda.
Phone: +55 (11) 2832 7070
Fax: +55 (11) 2832 7060
www.linak.com.br

Canada

LINAK Canada Inc.
Phone: +1 502 253 5595
Fax: +1 416 255 7720
www.linak-us.com

Czech Republic

LINAK C&S s.r.o.
Phone: +42 058 174 1814
Fax: +42 058 170 2452
www.linak.cz - www.linak.sk

Denmark - International

LINAK International
Phone: +45 73 15 15 15
www.linak.com

Denmark - Sales

LINAK DANMARK A/S
Phone: +45 86 80 36 11
Fax: +45 86 82 90 51
www.linak.dk

Finland

LINAK OY
Phone: +358 10 841 8700
www.linak.fi

France

LINAK FRANCE E.U.R.L.
Phone: +33 (0) 2 41 36 34 34
Fax: +33 (0) 2 41 36 35 00
www.linak.fr

Germany

LINAK GmbH
Phone: +49 6043 9655 0
Fax: +49 6043 9655 60
www.linak.de

India

LINAK A/S India Liaison Office
Phone: +91 120 4531797
Fax: +91 120 4786428
www.linak.in

Ireland

LINAK UK Limited (Ireland)
Phone: +44 (0)121 544 2211
Fax: +44 (0)121 544 2552
+44 (0)796 855 1606 (UK Mobile)
+35 387 634 6554
(Republic of Ireland Mobile)
www.linak.co.uk

Italy

LINAK ITALIA S.r.l.
Phone: +39 02 48 46 33 66
Fax: +39 02 48 46 82 52
www.linak.it

Japan

LINAK K.K.
Phone: 81-45-533-0802
Fax: 81-45-533-0803
www.linak.jp

Malaysia

LINAK Actuators Sdn. Bhd.
Phone: +60 4 210 6500
Fax: +60 4 226 8901
www.linak.my

Netherlands

LINAK Actuator-Systems B.V.
Phone: +31 76 5 42 44 40
www.linak.nl

New Zealand

LINAK New Zealand Ltd
Phone: +64 9580 2071
Fax: +64 9580 2072
www.linak.com.au

Norway

LINAK Norge AS
Phone: +47 32 82 90 90
www.linak.no

Poland

LINAK Polska
LINAK Danmark A/S (Spółka Akcyjna)
Phone: +48 22 295 09 70 /
+48 22 295 09 71
www.linak.pl

Republic of Korea

LINAK Korea Ltd.
Phone: +82 2 6231 1515
Fax: +82 2 6231 1516
www.linak.kr

Russia

LINAK LLC
Phone: +7 495 780 3161
Fax: +7 495 687 1426
www.linak.ru

Spain

LINAK Actuadores, S.L.U
Phone: +34 93 588 27 77
Fax: +34 93 588 27 85
www.linak.es

Sweden

LINAK Scandinavia AB
Phone: +46 8 732 20 00
Fax: +46 8 732 20 50
www.linak.se

Switzerland

LINAK AG
Phone: +41 43 388 31 88
Fax: +41 43 388 31 87
www.linak.ch - www.fr.linak.ch
www.it.linak.ch

Taiwan

LINAK (Shenzhen) Actuator systems Ltd.
Taiwan Representative office
Phone: +886 2 272 90068
Fax: +886 2 272 90096
www.linak.tw

Turkey

LINAK İth. İhr. San. ve Tic. A.Ş.
Phone: +90 312 4726338
Fax: +90 312 4726635
www.linak.com.tr

United Kingdom

LINAK UK Limited
Phone: +44 (0)121 544 2211
Fax: +44 (0)121 544 2552
www.linak.co.uk

DISTRIBUTORS

Argentina

NOVOTEC ARGENTINA SRL
Phone: 011-4303-8989/8900
Fax: 011-4032-0184
www.novotecargentina.com

Colombia

MEM Ltda
Phone: +[57] (1) 334-7666
Fax: +[57] (1) 282-1684
www.mem.net.co

India

Mechatronics Control Equipments
India Pvt Ltd
Phone: +91-44-28558484, 85
www.mechatronicscontrol.com

Indonesia

PT. HIMALAYA EVEREST JAYA
Phone: +6 221 544 8956,
+6 221 544 8965
Fax: +6 221 619 1925
Fax (Sales): +6 221 619 4658
www.hej.co.id

Iraq

Scan Medical Tech
Phone: +964 770 470 2202

Israel

NetivTech LTD
Phone: +972 55-2266-535
Fax: +972 2-9900-560
www.netivtech.com

Kingdom of Bahrain

Mechatronics Industrial Equipments
Phone: +973 17280059
Fax: +973 17910045
www.mechatronicsbh.com

Qatar

Mechatronics Industrial Equipments
Phone: +974 44581155
Fax: +974 44689135
www.mechatronicsqatar.com

Russia

OOO FAM
Phone: +7 812 3319333
Fax: +7 812 3271454
www.fam-drive.ru

Singapore

Servo Dynamics Pte Ltd
Phone: +65 6844 0288
Fax (Sales): +65 6844 0070

South Africa

Industrial Specialised Applications CC
Phone: +27 011 466 0346
www.isaza.co.za

United Arab Emirates

Mechatronics Industrial Equipments LL
Phone: +971 4 267 4311
Fax: +971 4 267 4312
www.mechatronics.ae

LINAK® accepts no responsibility for possible errors or inaccuracies in catalogues, brochures, and other material. LINAK reserves the right to change its products without prior notice. LINAK cannot guarantee product availability and reserves the right to discontinue the sale of any product. The user is responsible for determining the suitability of LINAK products for a specific application. All sales are subject to the 'Standard Terms of Sale and Delivery', available on LINAK websites.

LINAK and the LINAK logotype are registered trademarks of LINAK A/S. All rights reserved.



WE IMPROVE YOUR LIFE