

TECHLINE<sup>®</sup>  
IMPROVING FLEXIBILITY



Focus on  
mobility

[LINAK.COM/TECHLINE](http://LINAK.COM/TECHLINE)

**LINAK<sup>®</sup>**   
WE IMPROVE YOUR LIFE



# Understanding your needs

---

Physical disability does not necessarily mean reduced activity, but simply reduced mobility. Persons with disabilities face many challenges when it comes to mobility, e.g. in their homes, in the office, in the shopping mall, in the cinema or in their cars. It is an everyday occurrence. However, with the technological development, a wide range of aids to increase mobility are available for persons with disabilities today.

LINAK® has many years of experience as a subsupplier within this business and knows what it takes to supply reliable actuator systems that put self-reliance, people's safety and quality of life first.

## Fittings for cars

As an example, LINAK can provide a wide range of low voltage actuators for all kinds of movement in vehicle fittings for persons with disabilities. So why is LINAK the perfect partner for this exact application?

## LINAK actuators:

- Are very easy to install and they fit immediately to the electrical system of the vehicle
- Can be supplied with extra safety features
- Lift up to 1000 kg fast and steadily
- Are easy and fast to operate by means of hand controls, remote controls or switches
- Are designed to operate under harsh and rugged conditions with vibrations etc.
- Are maintenance-free products
- Offer a high degree of flexibility

*"LINAK provides a wide range of low voltage actuators for all kinds of movement in vehicle fittings for persons with disabilities. The actuators can lift up to 1000 kg fast and steadily."*

LINAK offers service  
worldwide

Please contact your local LINAK office with  
your enquiry



# What LINAK actuators do for the car

---

TECHLINE® actuator solutions provide easy electric linear movement for a wide range of vehicles especially designed to increase mobility for persons with disabilities. Their light weight, precise and smooth motion control as well as reliable performance in rough conditions make LINAK® actuators an ideal choice for these applications.

For the car, LINAK actuators offer improved ergonomics, easy access and exit of the vehicle, as well as easy loading of small mobility solutions such as wheelchairs etc.

## Rear door opener

Remote opening/closing of the rear door. Simple operation of the rear door will be mandatory for a wheelchair user

---

## Lift

Easily loading wheelchairs or scooters into boots. A lift like this can increase the independency of the user and make travelling easier

---



### Electrical seat

Gaining easy access to the driver's seat from a wheelchair with electric turntable seats



# What LINAK actuators do for the minivan

LINAK® actuators ensure user-friendly operation as well as high-quality and long lasting performance in various mobility solutions for minivans.

Due to their high flexibility the actuators can easily be customised for a specific mobility solution. Also, their small size and ability to interface with programmable control systems makes installation into applications even easier.

Curb sider lift



Scooter platform lift

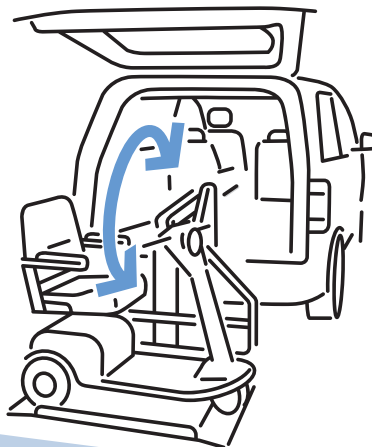



### Foldout ramp

Folding or unfolding of the wheelchair ramp for easy exit/entry for users of wheelchairs or scooters

### Kneeling system

# What LINAK actuators do for the van and small cars for wheelchair users

Within vans and small cars for wheelchair users, LINAK® actuators will help enhance safety and reliability while providing easy adjustment for ergonomic, self-reliance and comfort purposes.

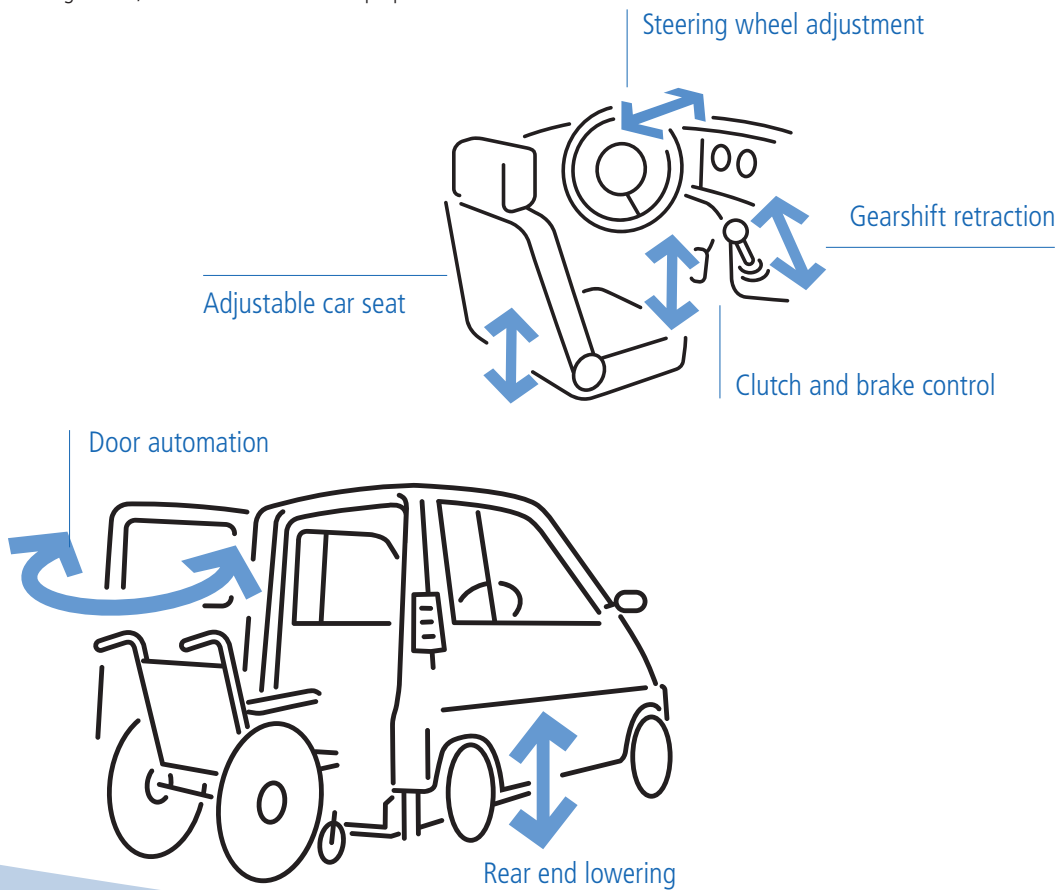

**Support railing**  
Adjustment of the support railing for safer entry/exit

**Platform lift**  
Steady lifting of the rear mounted platform for wheelchair or scooter transport

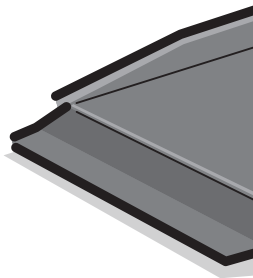

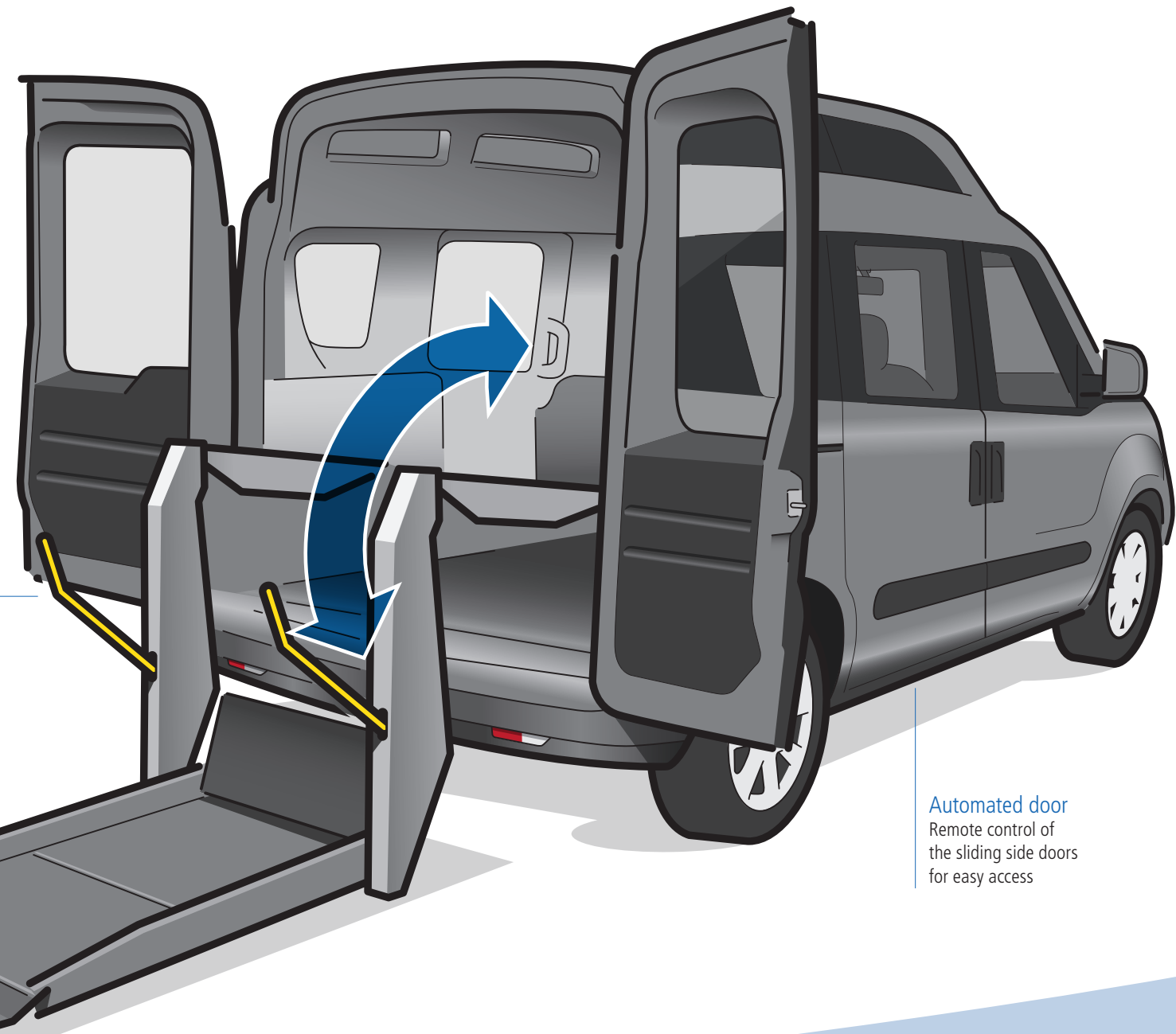

**Automated door**  
Remote control of  
the sliding side doors  
for easy access

# Explore the rich technology behind actuators



At the Actuator Academy™, you will find a library of videos and information about actuator components, actuator testing, and intelligent actuator control.

Find out what you should expect of a good industrial actuator, what affects its performance and efficiency, and how to best utilise your linear motion actuator.

We hope to inspire you and ultimately make you wiser on the moving electric revolution we are all part of.

**Happy exploring!**

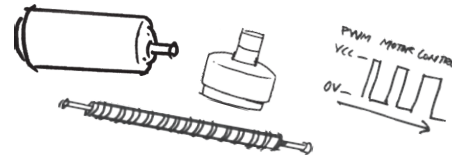
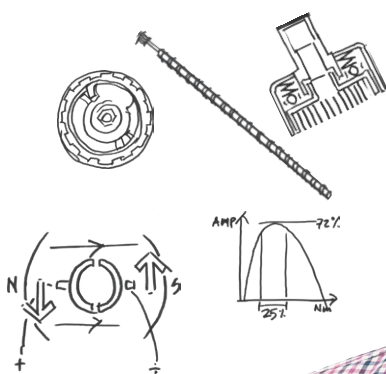

Check out the  
Actuator Academy

[LINAK.COM/  
ACTUATOR-ACADEMY](http://LINAK.COM/ACTUATOR-ACADEMY)

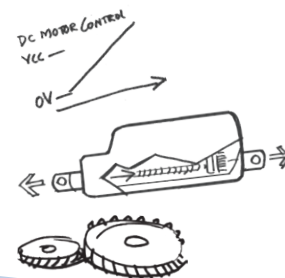

# Smart movement for mobility applications

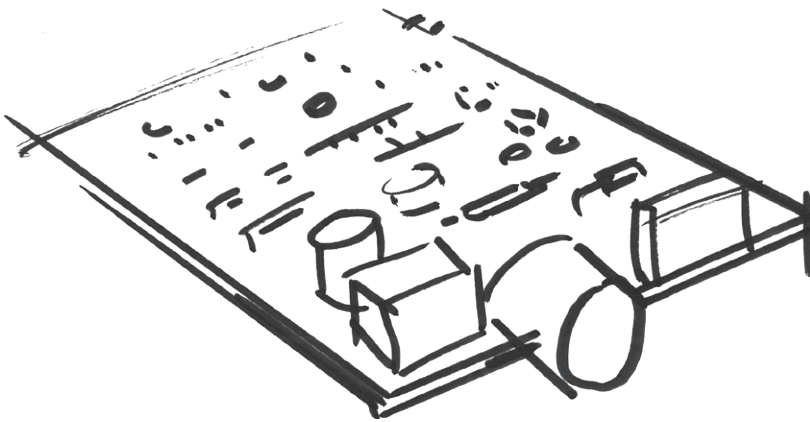

A LINAK® IC actuator with built-in controller reduces the number of external components and the need for a third-party supplier for power electronics.

It also offers a comprehensive range of interfaces and gives you access to productivity enhancing data - all delivered by a single supplier you can trust.

By helping you move smarter at every stage of your application process, from development, installation and integration to tailored movement and improved productivity, our IC actuators add value across the board.

## IC INTEGRATED CONTROLLER™

Choosing an IC actuator for your application is a smart move in many ways:

- Reduced complexity for faster development and production
- Flexible integration with a variety of industrial interfaces
- Data monitoring that minimise downtime and boost productivity
- Benefit from one single supplier



For more information on IC, please visit [LINAK.COM](http://LINAK.COM) or scan the QR code.

# Actuators for mobility applications

---

LINAK® industrial actuators offer a versatile array of movement solutions for mobility applications.

With **thrusts up to 15,000 N, max speeds up to 160 mm/s, and strokes between 20 and 999 mm**, the actuators are highly adaptable for a wide variety of applications.

Industrial actuators with **heavy-duty aluminium housings** are very suitable for use in corrosive environments. Having been thoroughly salt spray and chemical resistance tested and approved for ratings up to **IP66 and IP69K static**, these actuators will work reliably for years, even when exposed to salt, water, wind, and sun.

**Operating temperatures between -40°C to +85°C** make them fit for work in numerous settings.

Actuator LA37



Actuator LA36



Actuator LA35



Actuator LA33



Actuator LA25



Actuator LA23



Actuator LA14



Actuator LA12



# Accessories for mobility

## Motor controller TR-EM-208 - Complete control

- Variable power supply 12-36 V DC
- Overload protection - adjustable current limit 1-20 A
- Adjustable soft start and stop
- Several versions for different applications
- Integrated brake  
(\*)

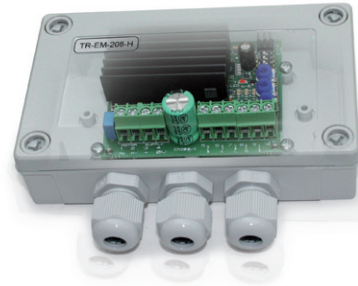

## Rocker switch - easy operation

- For all actuators with limit switches
- Easy operation of actuators without use of further electronics
- IP66 for outdoor use
- Easy to install
- Tested with an LA36 12 V DC for 50,000 operations  
(\*)



## Remote control - digital radio control

- Remote control transmitting up to 100 metres
- Dual channel receiver
- Several transmitters can be programmed for the same receiver
- Simple to use and install
- Dynamic codes ensure a high security level
- Supply voltage 12 or 24 V DC  
(\*)



(\* ) "The specified product is a third party product that is produced by third party and distributed by LINAK® as a supplement to the LINAK existing product range. It is the responsibility of the product user to determine the suitability of the product for a specific application. LINAK will at point of delivery replace/repair defective products covered by the warranty if promptly returned to LINAK."



If you use IC there is no need for these accessories!



## We understand your business

---

On the cooperational side, it must be easy for our customers to do business with LINAK®.

Therefore, we offer both standard components and customised solutions according to demand. In close cooperation with our sales engineering team you can develop an optimal solution that fits perfectly to your task and demands.

Our LINAK TECHLINE® division is committed to offering innovative solutions that help improve life for you and for the end-user of the system.



Resting on the pillars of the LINAK values

---



QUALITY

Built by market leading experts, using state-of-the-art technologies and perfected production methods, you can expect the same quality worldwide.



INNOVATION

Innovation is in our core. We take the lead and have the courage to make it real.



RESPONSIBILITY

We are responsible in what we do – towards customers, employees and environment. Creating trust is a natural part of who we are.



LOCAL  
& GLOBAL

From global presence to local understanding. We believe in world-wide support and being close to our customers.

# Testing programme

In each industrial application, the actuator is just one component of many, but at LINAK® we fully appreciate that it is of utmost importance to you and your customers. Not a single actuator leaves the factory until it has undergone a 100% function test.

Depending on the actuator type, various tests have been carried through. Please consult your local LINAK office or take a look at the actuator data sheet in question to get a thorough test overview.

This is your guarantee that a solution based on LINAK TECHLINE electric actuator systems is a solution that will work reliably for years and years.

“Our actuators must never malfunction. Therefore, it is important that all our products are tested inside and out, and to the extreme in a wide range of tests.”

- Claus H. Sørensen, Director R&D

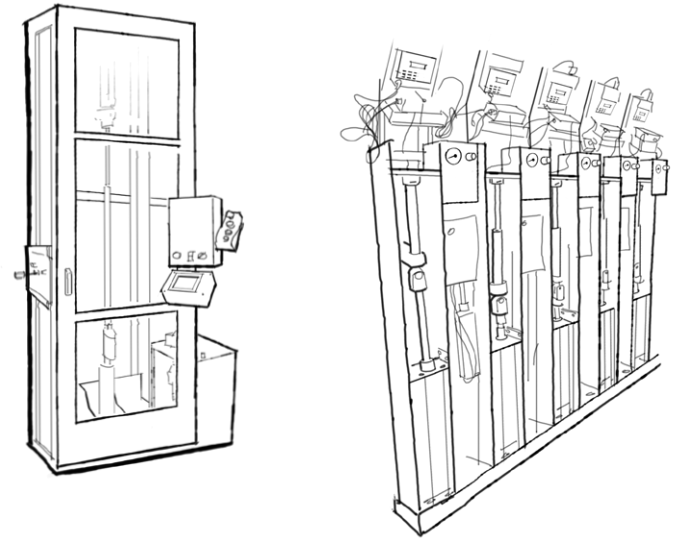

## Climatic tests:

In the climatic test the actuators are tested to operate in extreme temperatures as well as to endure rapid changes in temperature. In a dunk test, the actuators have to withstand repeating temperature fluctuations between +85°C to -40°C and still maintain full functionality and ingress protection.

<b>EN60529-IP6X</b>	- Dust
<b>EN60529-IPX6</b>	- Water
<b>ISO16750- IP69K</b>	- High pressure cleaning
<b>IEC60068-2-3</b>	- Moisture storage
<b>IEC60068-2-30</b>	- Operation in moisture
<b>ISO16750-4:2010</b>	- Dunk test
<b>EN60068-2-52</b>	- Salt spray
<b>BS7691 Section 6.11.2.4</b>	- Chemicals

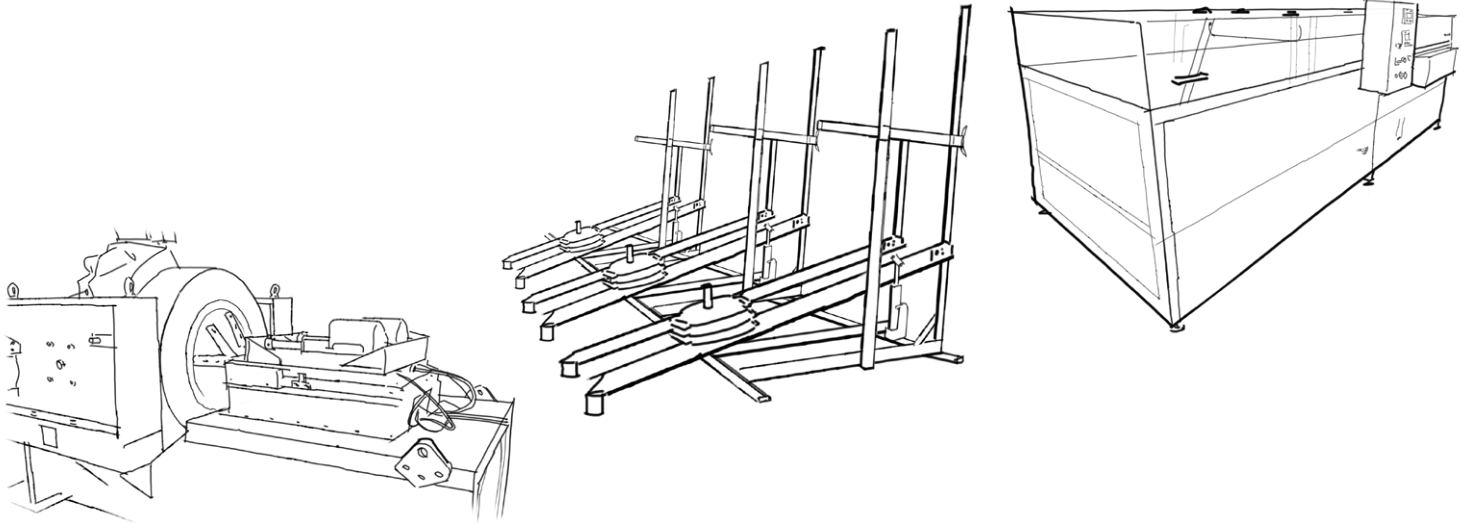

### Electrical tests:

All electrical parts are tested i.e. power supply, power and signals cables, control signals etc. Electrical immunity is tested according to industrial standards i.e. for radio noise, electrical discharge and burst.\*

<b>EN/IEC 61000-6-4</b>	- Generic standard emission industry
<b>EN/IEC 60204</b>	- Electrical equipment of machinery
<b>EN 50121-3-2</b>	- Railway applications - Rolling stock apparatus
<b>94/25/EC</b>	- Recreational crafts directive
<b>EN/ISO 13766</b>	- Earth moving machinery
<b>EN/IEC 61000-6-2</b>	- Generic standard immunity industry
<b>2004/104/EC</b>	- Automotive Directive
<b>EN/ISO 14982</b>	- Agricultural and forestry machines
<b>EN/ISO 13309</b>	- Construction machinery

\* These tests do not apply to third party products!

### Mechanical tests:

**Vibration:** The actuator must withstand continuous vibration in three directions.

**Shock:** The shock test puts the actuator through 3 shocks of up to 50 G in each of six directions.

**Bump:** The actuator receives bumps of up to 30 G in each of six directions several hundred times.

**EN60068-2-64 (Fh)** - Random vibration

**EN60068-2-27 (Ea)** - Shock

**EN60068-2-29 (Eb)** - Bump

Find out more about how we test actuators to the extreme:

[linak.com/segments/techline/tech-trends/testing/](http://linak.com/segments/techline/tech-trends/testing/)





For further information, please visit our website:  
**LINAK.COM/BUSINESS-AREAS/VEHICLES**

LINAK® accepts no responsibility for possible errors or inaccuracies in catalogues, brochures, and other material. LINAK reserves the right to change its products without prior notice. LINAK cannot guarantee product availability and reserves the right to discontinue the sale of any product. User is responsible for determining the suitability of LINAK products for a specific application. All sales are subject to the 'Standard Terms of Sale and Delivery', available on LINAK websites.

LINAK and the LINAK logotype are registered trademarks of LINAK A/S. All rights reserved.



**QUALITY**

Built by market leading experts, using state-of-the-art technologies and perfected production methods, you can expect the same quality worldwide.



**INNOVATION**

Innovation is in our core. We take the lead and have the courage to make it real.



**RESPONSIBILITY**

We are responsible in what we do – towards customers, employees and environment. Creating trust is a natural part of who we are.



**LOCAL  
& GLOBAL**

From global presence to local understanding. We believe in world-wide support and being close to our customers.