

DL20 / DL21

User Manual



Contents

| | |
|--|----|
| Preface | 3 |
| Important safety information | 4 |
| Informations importantes en matière de sécurité..... | 5 |
| The DESKLINE® system | 6 |
| Intended use | 6 |
| Warranty | 6 |
| Products | 7 |
| Safety instructions..... | 8 |
| Important safety instructions..... | 8 |
| General | 8 |
| Before installation, re-installation, cleaning, or troubleshooting | 9 |
| Before start-up | 9 |
| During operation | 9 |
| Repairs | 9 |
| Consignes importantes de sécurité..... | 11 |
| Declaration of Conformity..... | 12 |
| Manufacturer's declaration..... | 13 |
| Installation | 14 |
| Mounting the column..... | 14 |
| Mounting the feet | 15 |
| Mounting the tabletop | 19 |
| Assembly of bench systems..... | 20 |
| Bench options | 22 |
| Bench system notes..... | 23 |
| Mounting the CBD6S | 24 |
| Connecting the system | 25 |
| Initialising the system..... | 25 |
| Operation | 25 |
| Anti-collision..... | 26 |
| Anti-collision systems..... | 26 |
| Gyroscope | 27 |
| Piezo-electric sensor | 27 |
| Maintenance..... | 28 |
| Cleaning the desk panel | 28 |
| Repair and disposal..... | 29 |
| Servicing double-insulated products..... | 29 |
| Accessories and spare parts..... | 29 |

Preface

Dear User,

We are delighted that you have chosen a LINAK® product.

LINAK systems are high-tech products based on many years of experience in the manufacture and development of actuators, lifting columns, desk frames, electric control boxes, controls, batteries, accessories and chargers.

This User Manual does not address the end user. It is intended as a source of information for the equipment or system manufacturer only, and it will tell you how to install, use and maintain your LINAK electronics. The manufacturer of the end product has the responsibility to provide a User Manual, where relevant safety information from this manual is passed on to the end user.

We are convinced that your LINAK product/system will give you many years of problem-free operation.

Before our products leave the factory, they undergo both function and quality testing. Should you, nevertheless, experience problems with your product/system, you are always welcome to contact your supplier.

LINAK subsidiaries and some distributors situated all over the world have authorised service centres, which are always ready to help you. Locate your local contact information on the back page.

LINAK provides a warranty on all products, see [Warranty](#).

This warranty, however, is subject to correct use in accordance with the specifications, maintenance being done correctly, and any repairs being carried out at a service centre, which is authorised to repair LINAK products.

Changes in installation and use of LINAK systems can affect their operation and durability. The products may only be opened by authorised personnel.

This User Manual has been written based on the present technical knowledge. LINAK reserves the right to carry out technical modifications and keeps the associated information updated.

LINAK A/S

Important safety information

Safe use of the system is possible only when this document is read completely and the instructions contained are strictly observed.

Failure to comply with instructions marked with the "NOTICE" symbol may result in serious damage to the system or one of its components.

Read all instructions before using this product.

Important safety information on LINAK® products can be found under the following heading(s):



DANGER

Failure to comply with these instructions will result in severe personal injury.



WARNING

Failure to comply with these instructions may result in severe personal injury.



CAUTION

Failure to comply with these instructions can result in minor personal injury.



NOTICE

Failure to comply with these instructions can result in property damage.

READ AND SAVE THESE INSTRUCTIONS

Informations importantes en matière de sécurité

Une utilisation sûre du système n'est possible que lorsque ce document est lu dans son intégralité et que les instructions qu'il contient sont strictement respectées.

Le non-respect des instructions marquées du symbole "AVIS" peut entraîner de graves dommages au système ou à l'un de ses composants.

Lisez toutes les instructions avant d'utiliser ce produit.

Des informations de sécurité importantes sur les produits LINAK® sont disponibles dans la ou les rubriques suivantes :



DANGER

Le non-respect de ces instructions entraînera des blessures graves.



AVERTISSEMENT

Le non-respect de ces instructions peut entraîner des blessures graves.



ATTENTION

Le non-respect de ces instructions peut entraîner des blessures corporelles légères.



AVIS

Le non-respect de ces instructions peut entraîner des dommages matériels.

LIRE ET CONSERVER CES INSTRUCTIONS

The DESKLINE® system

This system is a DESKLINE system developed for desks

Intended use

This product is intended for use indoors in household and commercial usage areas.

Bench systems are intended for use in areas where children or people with cognitive disabilities are not anticipated to be present or, if present, closely supervised.

| Parameter | Operation | Storage and transportation |
|----------------------|-----------------------------|-----------------------------|
| Temperature | 10 to 40 °C | -10 to +50 °C |
| Relative humidity | 20% to 80% - non-condensing | 20% to 80% - non-condensing |
| Atmospheric pressure | 800 to 1060 hPa | 700 to 1060 hPa |
| Altitude | Max. 2000 m | N/A |



Do not use outdoors or in wet areas.



Do not use it in environments that have to be cleaned with aggressive detergents.

Warranty

The warranty terms for DESKLINE products are described in this warranty paper:

<https://cdn.linak.com/-/media/files/warranty/warranty-paper-deskline-eng.pdf>

Products

DESKLIFT™ columns

DL20



- 2-part PLUS™ column

DL21



- 3-part PLUS™ column

Control Box CBD6S

200 W



- 230 V AC, 50 Hz
- 120 V AC, 60 Hz

300 W



- 100-240 V AC, 50-60 Hz (universal)

Desk panels

| | | |
|-------------------------------------|---|---|
| With up/down drive | <ul style="list-style-type: none"> • DPA • DPB • DPH | <ul style="list-style-type: none"> • DP1K • DPF1K • DPG1K • DPI1K |
| Desk panels with display | <ul style="list-style-type: none"> • DPF1D | |
| Desk panels with memory | <ul style="list-style-type: none"> • DPF1M | <ul style="list-style-type: none"> • DPG1M • DPG1B |
| Desk panels with display and memory | <ul style="list-style-type: none"> • DP1CS • DPT | <ul style="list-style-type: none"> • DPF1C • DPG1C • DPI1C |

Safety instructions

Important safety instructions

General



DANGER

Plugged-in products

Risk of electric shock

- Always unplug this product from the electrical outlet before assembling, disassembling, cleaning, or servicing.
- Only use the product indoors in dry locations.



WARNING

General precautions

Risk of burns, fire, electric shock, or injury to persons

- Unplug from outlet before putting on or taking off parts.
- It is important that everyone who is to connect, install, or use the systems has the necessary information and access to this User Manual. Follow the instructions for mounting - there is a risk of injury if these instructions are not followed.
- Close supervision is necessary when this product is used by or near children, invalids, or disabled persons.
- If there is visible damage to the product, do not install or use the product.
- Ensure that the cable and the plug are not damaged, and keep the cable away from heated surfaces.
- Use this product only for its intended use as described in this User Manual. Do not use attachments not recommended by the manufacturer.
- Never insert any object into any opening.
- During construction of applications in which the system is to be fitted, there must be no risk of personal injury, for example squeezing of fingers or arms.
- Do not open the product.



CAUTION

Objects above and below the desk

Risk of personal injury and material damage

- Ensure free space above and below the application to avoid entrapment and blocking the movement in either direction.

Before installation, re-installation, cleaning, or troubleshooting

- Stop the system.
- Unplug the power cable.
- Relieve the system of any loads, which may be released during the work.
- Review the assembly instructions to confirm that the appropriate critical components and accessories are being used with this product.

Before start-up

- Make sure that the system has been installed as instructed in this User Manual.
- Make sure that the voltage of the system matches the mains voltage before connecting the system to the mains.
- Always use the supplied power cable.

During operation

- If the system makes unusual noise or smells, unplug the mains cable immediately.
- Observe the maximum load/self-lock (per column)

| Column | Max. load (N) | Self-lock (N) |
|-----------------|---------------|---------------|
| DL20 | 800 | 800 |
| DL21 | 800 | 800 |
| DL21 High-speed | 600 | 1200 |

- Duty cycle: 10 %, max. 2 minutes continuous use at full load followed by 18 minutes pause.
- Take care that the cables are not damaged.



CAUTION

Load on the desk

Risk of injury to persons and of malfunction

- Do not overload the frame.
- Place heavy load centrally on the desk.
- Do not use the desk as a work bench.
- Do not use the frame for lifting persons.
- Do not stand on the desk while it is driving up or down.



NOTICE

Duty cycle

Risk of malfunction

- Do not exceed the duty cycle.

Repairs



WARNING

Opening the product

Risk of injury to persons

- Do not open the DESKLINE® product.

In order to avoid the risk of malfunction, all DESKLINE® repairs must only be carried out by authorised LINAK workshops or repairers, as special tools must be used and special gaskets must be fitted. Lifting units under warranty must also be returned to authorised LINAK workshops.



WARNING

- This appliance can be used by children aged from 8 years, and by persons with reduced physical, sensory or mental capabilities, or lack of experience and knowledge, if they have been given supervision or instruction concerning use of the appliance in a safe way and understand the hazards involved.
- Children shall not play with the appliance. Cleaning and user maintenance shall not be made by children without supervision.

Only for US and Canadian markets

- Persons who do not have the necessary experience or knowledge of the product/products must not use the product/products. Besides, persons with reduced physical, sensory, or mental abilities must not use the product/products, unless they are under surveillance or they have been thoroughly instructed in the use of the apparatus by a person who is responsible for the safety of these persons.
- Moreover, children must be under surveillance to ensure that they do not play with the product.
- It is the operator's responsibility to ensure that there is free space for the application to move without risk for the operator or bystanders before operating the application.

Consignes importantes de sécurité



AVERTISSEMENT

- Cet appareil peut-être utilisé par des enfants âgés de 8 ans et plus, ainsi que les personnes dont les capacités physiques, sensorielles ou mentales sont réduites ou ayant un manque d'expérience et de connaissance si elles ont bénéficié d'une surveillance ou d'instructions concernant l'utilisation de l'appareil en toute sécurité et compris les risques encourus.
- Les enfants ne doivent pas jouer avec l'appareil. Le nettoyage et l'entretien ne doivent pas être réalisés par des enfants sans surveillance

Seulement pour les marchés américains et canadiens

- Les personnes qui n'ont pas l'expérience ou les connaissances nécessaires sur le ou les produit(s) ne doivent pas le ou les utiliser. Par ailleurs, les personnes ayant des capacités physiques, sensorielles ou mentales réduites ne doivent pas utiliser le ou les produit(s), sauf si elles sont sous surveillance ou ont suivi une formation approfondie de l'utilisation de l'appareil par l'individu responsable de la sécurité de ces personnes.
- De plus, les enfants doivent-être sous surveillance afin de s'assurer qu'ils ne jouent pas avec le produit.
- Il est de la responsabilité de l'opérateur de s'assurer qu'il y a de l'espace libre pour que l'application puisse se déplacer sans risque pour l'opérateur ou les passants avant d'utiliser l'application.



ATTENTION

Charge sur le bureau

Risque de dommages corporels et de dysfonctionnement

- Ne pas surcharger le cadre.
- Placer la charge lourde au centre du bureau.
- Ne pas utiliser le bureau comme table de travail.
- Ne pas utiliser le cadre pour soulever des personnes.
- Ne vous tenez pas debout sur le bureau pendant qu'il monte ou descend.

Declaration of Conformity

LINAK A/S
Smedevænget 8
DK - 6430 Nordborg

hereby declares under our sole responsibility that LINAK DESKLINE® Actuator System, model: **CBD6S**, for use in elevation tables, composed of:

Control Box(s) CBD6Sa000b0A-c09,
(Where -a: can be P, C or H, -b: can be 2, 3 or 4 and -c: can be 0 or 7)

together with an optional combination of:

Linear Actuator(s) **LA31**: 31abcH-defff50S, (Where -a: can be 1, 3, 6 or 7; - b can be from 1 to 8, or A or B; - c can be from 0 to 4; - d can be 0 or 1; - e can be 0 or 1; - fff can be max 500)

Built in actuator(s) **DB5, DB6, DB14**: DBabbcdefghhiii, (Where: - a: can be 5, 6 or 14;; - b: can be 0, 1, 3, 4 or 9; - c: can be 0, 1, B, L or S; - d: can be 0, 1 or 2; - e: can be 0, A, B or X; - f: can be 0, or A; - g: can be from 0, M, S, E, T or V; - hhh: can be from 000 to 675; - iii: can be from 000 to 630);

Lifting Column(s) **Standard columns**: DLabcdeffghhiii, (Where: - a: can be 1A, 4S, 5, 6, from 8 to 12, from 14 to 21; - b: can be 0,1, 2, 3, 4 or 5; - c: can be 0, A, B, D, W or x; - d: can be 0, 1, L, R or X; - e: can be A, B, D or X; - f: can be 0, N, M, P or x; - g: can be 0, E, T or V; - hhh: can be from 600 to 1100; - iii: can be from 000 to 785);
DL12: DL12abcdeffghh (where - a can be A or B; - b can be 0 or E; -c can be 0, L, R or X; - d can be A, B, D or X; - e can be 0 or M; - f can be 0 or E; - ggg can be max 1100; - hhh can be max 785)
DL7: DL73a0b00470645 (where - a can be 0 or R; - b can be A, B, C or D)
DL2: DL2abCdeffggg (where - a can be 3, 6 or 7; - b can be from 0 to 3; - c can be A or B; - d can be 0, F or G; -e can be from 0 to 7; - fff can be from 300 to 500; -ggg can be from 445 to 655)
DF2L: DF2La0000bcP0dddeee (Where -a: can be 05, 06, 18, 19; -b can be 0, V, H; -c can be A, B, D; -ddd can be from 500 to 665; eee can be from 475 to 602)
BASELIFT: BASE1000A0F100100
LC1: LC1aaaxxbbbb0cd0eee0Gf4+g (where -a can be 060 or 100; -xxx can be 200 to 665; -bbbb can be numbers or letters; -c can be 0, H or M; -d can be A, B or C; -eee can be from 275 to 560; -f can be 0, 1 or 2; and -g can be A or E.

Desk Panel(s) DPA, DPB, DPH, DPF1K, DPF1M, DPF2K, DPF3K, DPF1C, DPF1D, DPF1U, DPF1W, DPF4T, DPG1K, DPG1M, DPG1B, DPG1C, DPT, DP1V01, DP1CS, DP1K, DP1U, DP2K, DP3K, DPN, DPWA, DPI-K, DPI-C

Accessories BLE2LIN (BLE2LIN002, BLE2LIN003), DESK SENSOR 1, USB2LIN, DCCconnector, CHUSB, BA001, BP10BL

Complies with EMC Directive: **2014/30/EU** (OJ L 96, 29.3.2014, p. 79–106) according to following standards: EN 61000-6-2:2005/AC:2005, EN 61000-6-3:2007/A1:2011/AC:2012 (and subsequent EN 61000-3-2:2014 and EN 61000-3-3:2013)

Complies with Low Voltage Directive **2014/35/EU** (OJ L 96, 29.3.2014, p. 357–374) according to the standard: EN 60335-1:2012+AC:2014+A11:2014+A13:2017+A1:2019+A14:2019+A2:2019+A15:2021 EN 62233:2008 + AC:2008

Complies with Directive **2011/65/EU** of the European Parliament and of the Council of 8 June 2011 on the restriction of the use of certain hazardous substances in electrical and electronic equipment (OJ L 174, 1.7.2011, p. 88–110) and Directive **2015/863** (OJ L 137, 4.6.2015, p. 10–12) (amending Annex II to Directive 2011/65/EU) according to the standard: EN IEC 63000:2018

Additionally, BA001 complies with Battery Regulation (EU) 2023/1542 Article 6.

And the applicable Desk Panels and Accessories complies with the Radio Equipment Directive **2014/53/EU** (OJ L 153, 22.5.2014, p. 62–106) according to the standards listed in the RED DoC for the individual radio products.

Other specification:

The system does also comply with the standard: EN 61000-6-2:2019 and EN 13849-1:2015 SRP/CS Cat. B, PL = b and SRESW PL = b, Note 1: Exempted CBD6S with SW03003007 printed on the label.

Nordborg, 2024-08-14

LINAK A/S
Dragan Macura
Regulatory Compliance Manager
Deskline and Homeline Segments
Authorized to compile the relevant technical documentation

Original Declaration

Manufacturer's declaration

DECLARATION OF INCORPORATION OF PARTLY COMPLETED MACHINERY

LINAK A/S
Smedevænget 8
DK - 6430 Nordborg

Herewith declares that LINAK DESKLINE® products as characterized by the following models and types:

Control Boxes: CBD6Sa000b0A-c09 (Where -a: can be P, C or H, -b: can be 2, 3 or 4 and -c: can be 0 or 7)

Linear Actuators: LA31

Built in actuator(s): DB5, DB6, DB14,

Lifting Columns: DL1A, DL4S, DL2, DL5, DL6, DL7, DL8, DL9, DL10, DL11, DL12, DL14, DL15, DL16, DL17, DL18, DL19, DL20, DL21, LC1

Desk Panels: DPA, DPB, DPH, DPF1K, DPF1M, DPF2K, DPF3K, DPF1C, DPF1D, DPF1U, DPF1W, DPF4T, DPG1K, DPG1M, DPG1B, DPG1C, DPT, DP1V01, DP1CS, DP1K, DP1U, DP2K, DP3K, DPN, DPWA, DPI-K, DPI-C

Accessories: BLE2LIN002, BLE2LIN003, DESK SENSOR 1, USB2LIN, DCConnector, BA001

complies with the following parts of the Machinery Directive 2006/42/EC, ANNEX I, *Essential health and safety requirements relating to the design and construction of machinery*:

- 1.1.2 a) Special use*
- 1.1.2 b) Selection of the most appropriate methods*
- 1.1.2 c) Foreseeable misuse*
- 1.1.2 d) Operator constraints due to the use of personal protective equipment*

1.1.3 Materials and products*

- 1.2.1 Safety and reliability of control systems
- 1.2.2 Control devices. Shape, readability, overview*
- 1.2.3 Starting*
- 1.2.4 Stopping*

- 1.5.1 Electricity supply
- 1.5.10 Radiation. EMC. Emission of electromagnetic radiation, X-rays, γ -rays*
- 1.5.11 External radiation*

*need to be further evaluated in the end product

We confirm that prior to market introduction the relevant technical documentation is compiled in accordance with part B of Annex VII and the assembly instruction pursuant to Annex VI.

This documentation or part hereof will be transmitted by post or electronically to a reasoned request by the national authorities.

The products mentioned in this document are to be combined for use in height adjustable furniture.

This partly completed machinery must not be put into service until the final machinery into which it is to be incorporated has been declared in conformity with the provisions of the Machinery Directive 2006/42/EC where appropriate.

Nordborg, 2024-02-21

LINAK A/S
Dragan Macura
Regulatory Compliance Manager
Deskline and Homeline Segments
Authorized to compile the relevant technical documentation

Original Declaration

Installation



WARNING

Plastic bags

Risk of suffocation

- Keep the plastic bags away from babies and children.



LINAK recommends using the DESKLINE® system in push applications with the motor housing mounted upwards.



Do not bolt the columns to the floor so that free movement is obstructed. This could cause serious damage to the columns in fault situations.

Mounting the column

Mounting the motor housing

The motor housing has six M6 threaded holes for mounting on the top frame.

1. Mount the motor housing on the top frame using six M6 screws with the following specifications:
Quality: Min. grade 8.8
Length: Max. 10 mm (plus top frame thickness). The screw must not go further than max. 10 mm into the motor housing
2. Fasten the screws thoroughly (torque: max. 7.5 Nm).

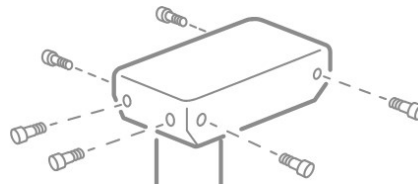

Figure 1 Always use six M6 screws for mounting the motor housing on the top frame

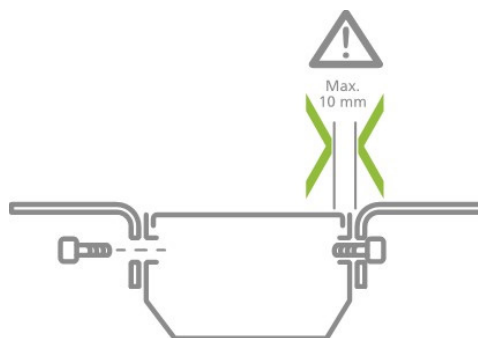

Figure 2 Mounting screws must not go further than max. 10 mm into the motor housing



Sufficient stability of the desk is only obtained if all six M6 screws are used for mounting the motor housing on the top frame. Tests with fixing the motor housing using only four M6 screws have proved that the torsional stability of the desk is insufficient.

Alternatively, use the Kick & Click™ top frame and avoid screws to get easy desk assembly. Visit the [Kick & Click](#) product website for further details.

Mounting the feet

The bottom plate has four M6 and two M8 threaded holes.

1. Mount the desk foot on the column bottom using four M6 or two M8 screws with the following specifications:
 Quality: Min. grade 8.8
 Length: Min. 10 mm (plus foot thickness);
 Max. 16 mm (plus foot thickness) for M6
 Max. 14 mm (plus foot thickness) for M8
2. Fasten the screws thoroughly (torque: max. 10 Nm).

The holes in the foot must be sufficiently larger than $\varnothing 6/\varnothing 8$ to ensure space for the screw heads to be screwed fully into the foot.

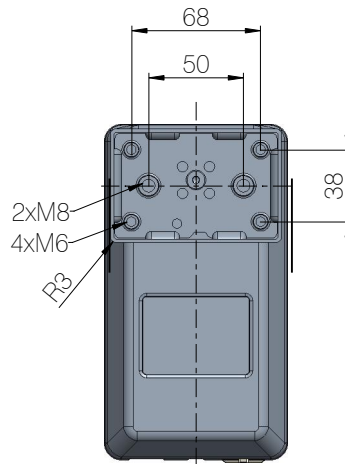

Figure 3 Bottom plate

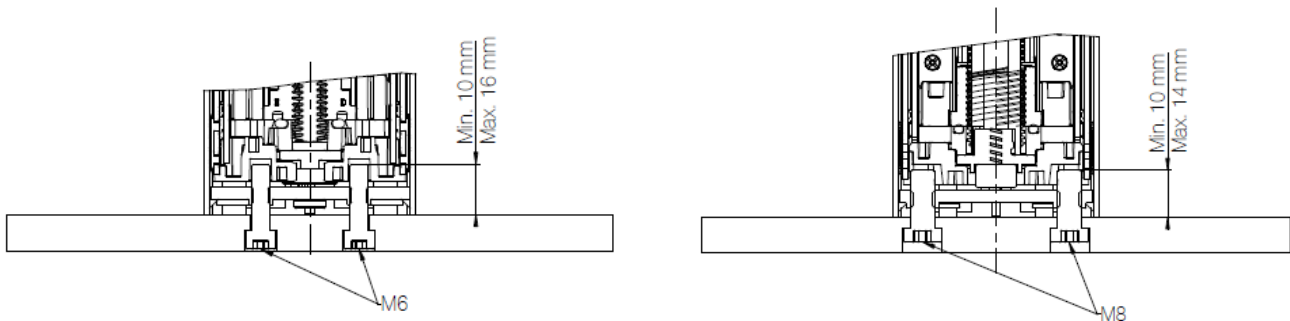
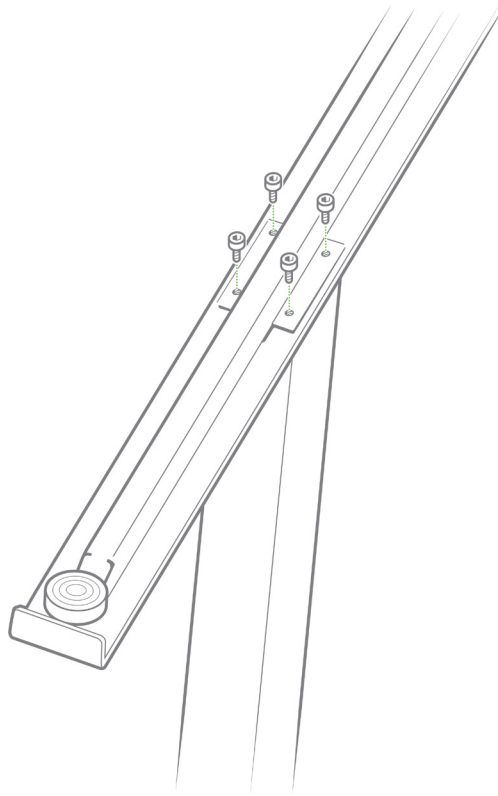
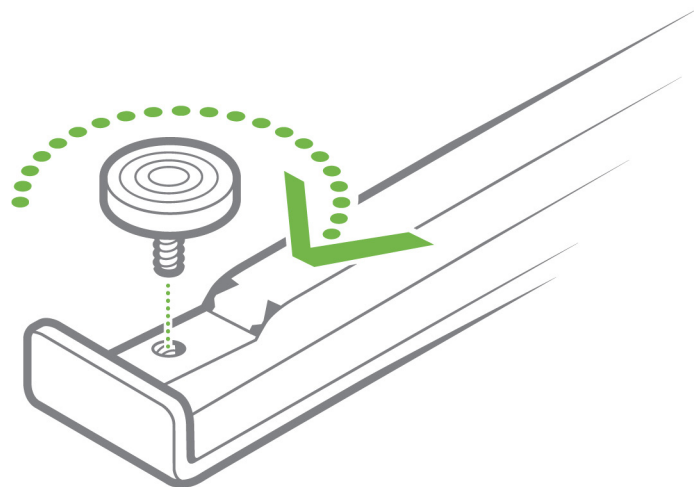

Figure 4 Column bottom mounted on desk foot (left: M6; right: M8)

1. Mount the feet on the columns using supplied screws. Max. torque: 10 Nm.



2. Mount the adjustment screws.



Click-on

The Click-on Feet can only be used with columns with pre-mounted mounting screws and plastic plate.

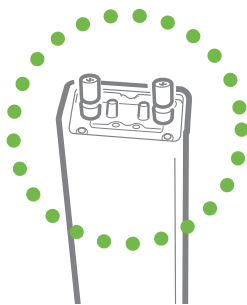

Mounting

1. Align the holes in the foot with the screws on the column.

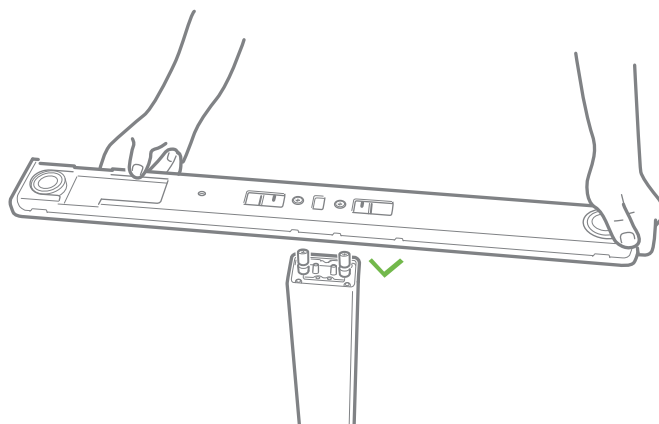

2. Press down quickly until a 'Click' is heard.

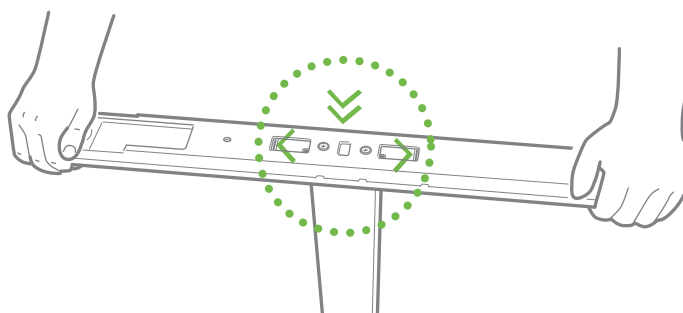

3. Ensure that locking plates snap inwards and lock the screws.

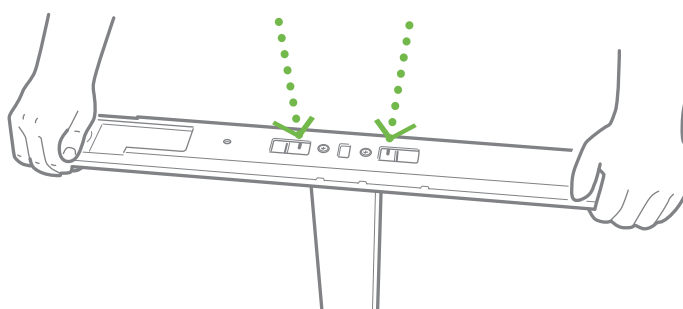

The foot is now mounted on the column.

Disassembly

1. Unscrew the two M8 screws until both mounting screws are loosened completely. Switch between the two screws after approximately five turns.

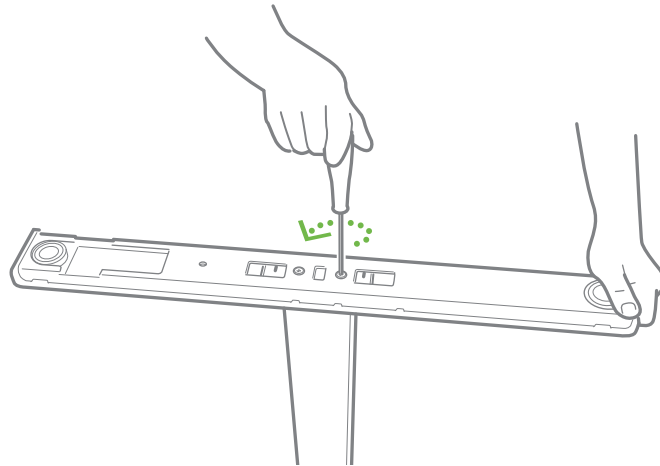

2. Remove the foot from the column.

Mounting the tabletop

The sound from the lifting column spreads as vibrations to the tabletop which amplifies the sound. This can, however, be reduced.

1. Place vibration/shock-absorbing material between tabletop and top frame.

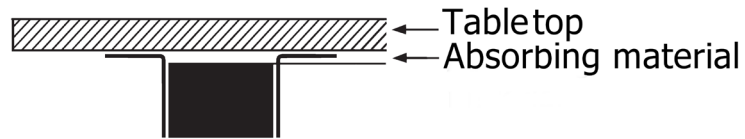

Figure 5 Assembled desk

Placing the monitor

Placement of a monitor directly above the motor housing may cause malfunction of the monitor. Magnets inside the motor may interrupt the picture on the monitor depending on the distance and type of monitor. If this is the case, the problem may be solved by placing an iron plate/tube or another magnetic material, somewhat larger than the motor housing, between the motor and the tabletop.

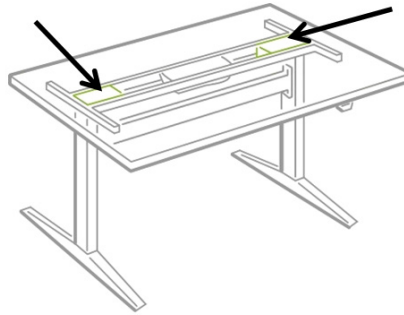
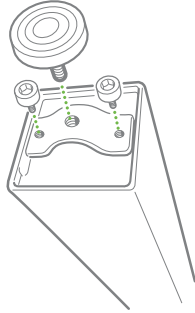

Figure 6 Recommended placement of an iron plate/tube or another magnetic material

Assembly of bench systems

Assembling the top frames

1. Assemble both top frames and mount them on the tabletops.
2. Mount the columns.
3. Mount the feet
 - 3.1. Mount the bench feet on the columns using two M8 mounting screws.
 - 3.2. Mount the adjustment screws.



Assembling the bench system

1. Mount the cross members.
 - 1.1. Mount the M8 x 40 mm threaded pins in the bench brackets on the columns.
 - 1.2. Use a screwdriver to fasten the pins (max. torque 2 Nm).

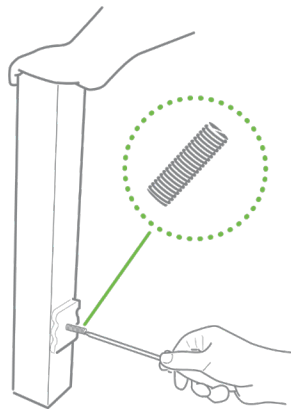

- 1.3. Mount a hex flange nut on each pin.

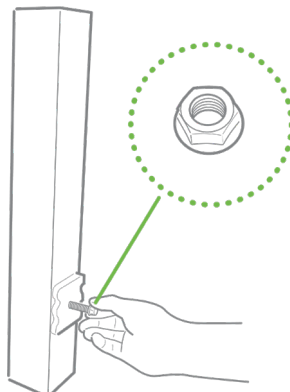

- 1.4. Place the cross members on the pins using the guiding holes in the cross members. The opening in the cross member must face upwards.

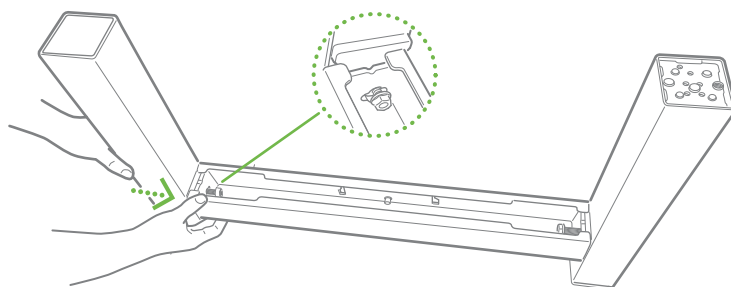

- 1.5. Fasten the hex flange nuts by hand and tighten them using an M8 wrench (max. torque 16 Nm).

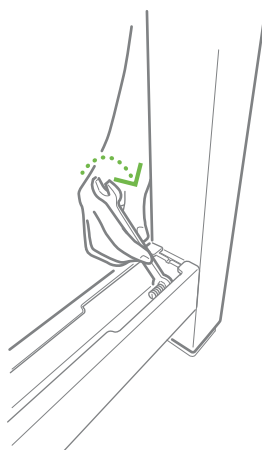

The bench system is now assembled.

Bench options

Cable tray

A cable tray can be mounted in a bench system to ease cable management.



Be careful not to squeeze cable or fingers when adjusting the cable tray length.

1. Place the hooks on the cable tray bottom part in the slots on one of the cross members.

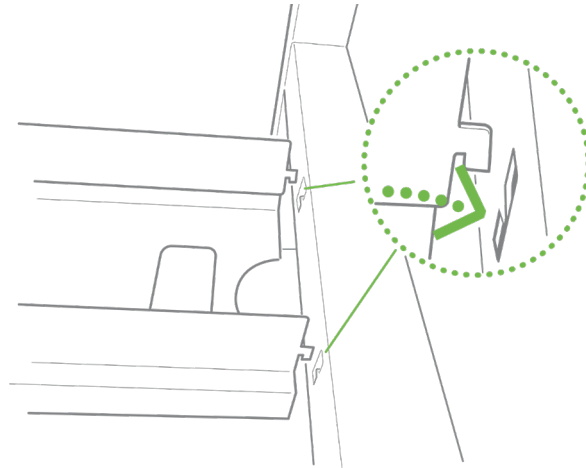

2. Press down until a click is heard and the cable tray is fixed in place.

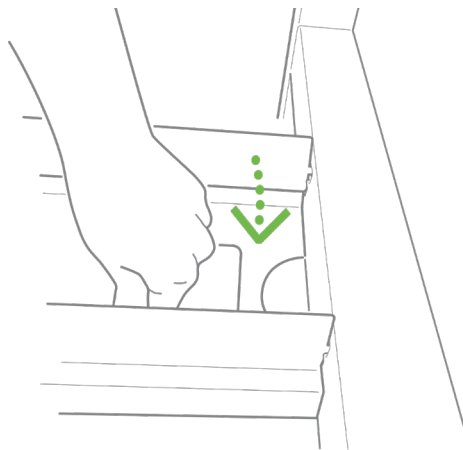

3. Extend the cable tray to fit the distance between the cross members and mount the cable tray on the other cross member.
4. Extend the cable tray top part to fit the bottom part length and place the top part on the bottom part.



Do not use the cable tray as a foot rest, a stair, or a shelf. There is a risk of falling down and getting squeezed or injured.

Bridge

For connecting multiple bench systems, use a bridge.

1. Place the bridge on top of the cross member on two bench systems and press down until a click is heard.

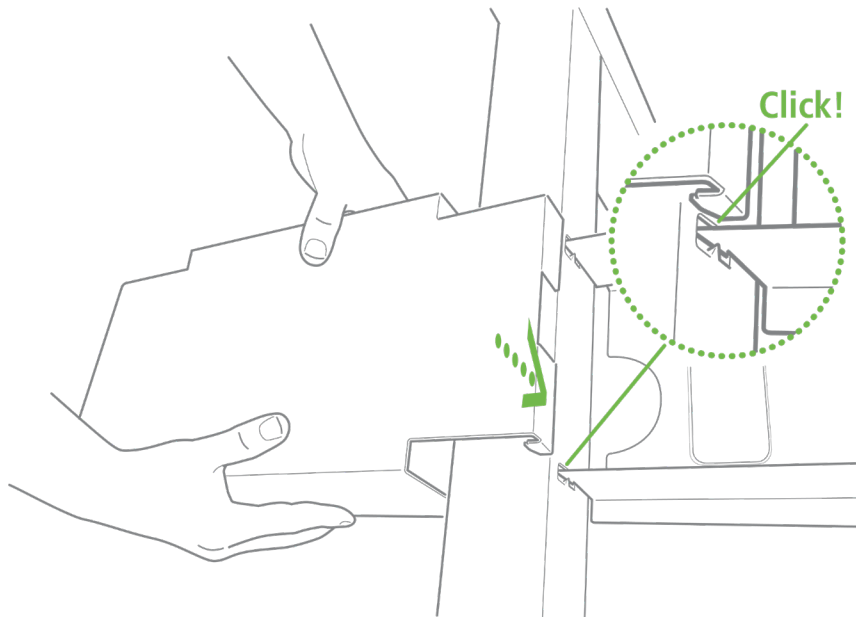

The two bench systems are now connected.

Privacy screen option

The cross members have two M6 holes for mounting a privacy screen between two benched desks.

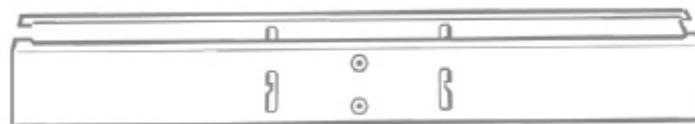

Max. torque: 10 Nm.

Bench system notes

In case DS1 devices are installed in the bench system, please note:



If one of the desks is driving up or down, and the other desk is being pushed or suddenly moves, the benching may cause the DS1 to trigger and stop the driving of the desk.

DESKLINE bench systems

For creation of a complete DESKLINE bench system, join two assembled desks by use of two cross members. Mount bench feet on the columns.

Mounting the CBD6S



Do not pack the CBD6S in heat-insulating material.
Place the CBD6S so it can emit heat through its surface to the surroundings.

1. Plug the mains cable into the CBD6S.
2. Place the mains cable in the groove for cable relief.



3. If needed, place the other cables in the grooves to optimise the desk design and manage the system cables.



4. Mount the CBD6S using two screws with a head diameter of 10 mm (8 to 10 mm can be used).
5. Fasten the mounting screws (max. torque 1 Nm).

Notes:

- If the control box is mounted in a top frame bar with the width of the motor housing, it can be mounted with one screw only
- The surface to which the control box is mounted should have an evenness better than ± 0.5 mm
- The control box can also be mounted using one or two M6 nuts and screw counterparts
- The mains plug must be accessible when the CBD6S is mounted so that the supply to the CBD6S can be disconnected if replacement is required



The builder of the equipment shall ensure that the use of the component complies with relevant standards – such as the Machine Directive. Care must be taken to avoid squeezing of cables as it can cause movement of the system!



The control box must only be connected to the voltage stated on the label.



It is important to ensure that the motor cables are fixed, but not tightened, near the control box **and** near the columns.

Fix the cable to the tabletop using a clip observing the **30 mm minimum bending radius (R)**.



Connecting the system

1. Connect the first DL/DB to socket 1 next to control port A2 on the control box using the 6-pin plug on the motor cable. Channel 1 is the channel closest to the control port.
2. Connect further DL/DB to sockets 2, 3 and 4 in sequence.
3. Connect the desk panel to control port A1 or control port A2.
4. Check that the voltage stated on the label corresponds to the mains power. If not, do not plug in the mains cable.
5. Plug in the mains cable.
6. Switch on the power.

Initialising the system

Downward direction

1. Press the desk panel to drive the desk down. Keep pressing the desk panel. The legs/actuators run down to the "buffer" causing cut-off due to excess current, after which they run approx. 3 mm upwards and thereby free of the "buffer".
2. Release the desk panel when the movement stops.

The system is now initialised in downward direction.

Upward direction

PIEZO columns (IID):

No initialisation in upward direction required.

Non-PIEZO columns (no IID):

The first two times the system moves into end stop in upward direction, the system runs approximately 5 mm back to initialise in upward direction.

Operation

For operation of the DESKLINE® system, please refer to the relevant desk panel operating guide which is available on our website: <https://www.linak.com/user-manuals/deskline/>

Anti-collision

Anti-collision systems

When using height-adjustable desks there is always a risk of driving the desk into an object – solid or soft. This could cause damage to the desk or the object or – if the desk tilts – damage to computers, monitors, and other objects placed on or close to the desk.

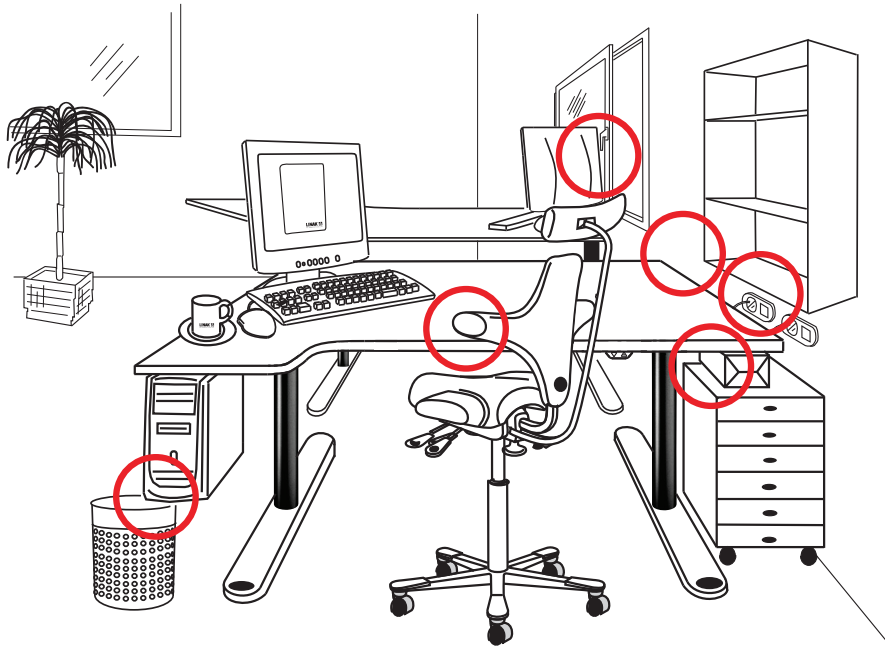

There are various ways to protect the desk from being damaged when driven into such objects. This feature is called an anti-collision system. To a certain extent, this feature also increases the personal safety, but it does not comply with the legislation covering personal safety.

The way to minimise the damage to a desk is fast detection of a collision with an object followed by reverse driving of the desk.

LINAK® offers three types of anti-collision systems.

- Gyroscopic sensor
- Piezo-electric sensor

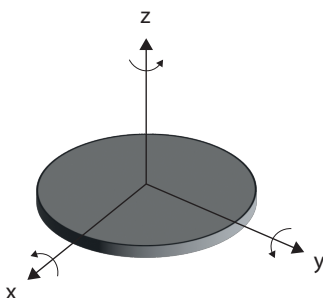

Gyroscope

The gyroscopic sensor reacts on even the smallest tilting in any direction with respect to its position at the beginning of the desk drive. When the desk runs into an object, the tabletop will start tilting and the gyroscopic sensor detects a collision.



DS1



DPF



DPI

Troubleshooting

The gyroscopic sensor is very sensitive and may cause false triggering if not mounted correctly.

To achieve the best possible performance of the gyroscopic sensor, please observe the following:

DS1:

Install the DS1 on the tabletop via either a CBD6S or a T-splitter.

Desk panels:

Mount the desk panel on a surface that is flat and without any bulges.

Mount the desk panel on a hard surface.

Do not place soft material between the tabletop surface and the desk panel.

In case of false triggering, please check this list:

- Make sure that the control box or T-splitter is fixed securely to the table (only relevant for DS1).
- Make sure the cables connected next to the DS1 in the control box or T-splitter are fastened thoroughly and **cannot** touch the DS1.
- If the desk is unstable, it may result in false triggering. Make sure the desk is stable and cannot tilt back and forth by adjusting the screws under the feet.
- Make sure that no objects, such as cables or furniture under the desk, can stop the driving up or down of the desk.
- If none of the above helps:
 - unplug the DS1/desk panel
 - wait 10 seconds
 - plug the DS1/desk panel back in

Piezo-electric sensor

The piezo-electric sensor is an integrated electronic sensor, which reacts on load changes. If the desk drives into an obstacle, the load changes. This load change is picked up by the piezo-electric sensor and the signal is sent to the control box.



Do not use the DL column with PIEZO in combination with a crossbar or a foot construction where you place the column in a tube welded on the foot.

Maintenance

Clean dust and dirt from the outside of the system at appropriate intervals and inspect for damage and breaks.

Inspect connections, cables, and plugs without disconnecting, and check functioning as well as fixing points.



CAUTION

Loose screws

Risk of loss of stability

- Check for loose screws on a regular basis. Fasten if necessary.

Cleaning the desk panel

Clean your desk panel with a soft damp cloth. Universal cleaning detergents may be used.

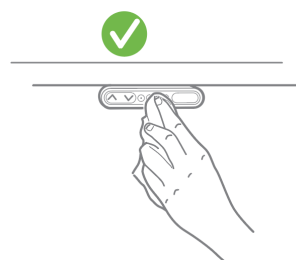
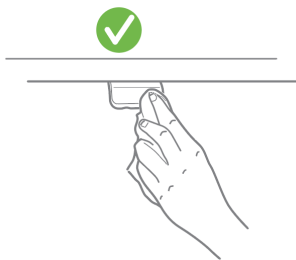

For disinfection of the desk panel, use a 70 percent isopropyl alcohol either as a wipe or add a small amount to a soft cloth.

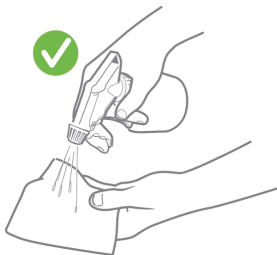

CAUTION

Risk of damaging the desk panel

The desk panel is not a sealed unit and there are electronics inside it.

- Ensure that liquids or moisture does not enter an opening. It may damage the PCB and ruin the desk panel.
- Avoid spraying the cleaning agent or disinfectant directly on the desk panel.

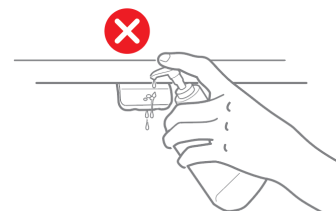
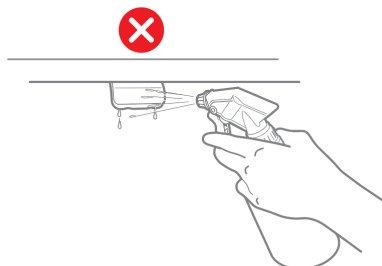

- Cleaning agents and disinfectants must not be highly alkaline or acidic (pH value must be 6 to 8), and they must not contain bleach or chlorine.
- Do not use hand sanitizer gel as a cleaning agent.

Repair and disposal



WARNING

Opening the product

Risk of injury to persons and of malfunction

- Do not open the product unless you are authorised to do so.

Only an authorised LINAK® service centre should repair the LINAK products. Products to be repaired under warranty must be sent to an authorised LINAK service centre.

In order to avoid the risk of malfunction, all product repairs must only be carried out by an authorised LINAK Service shop or repairers, as special tools and parts must be used.

If a product is opened by unauthorised personnel there is a risk that it may malfunction at a later date.

LINAK systems or components may be disposed of, possibly by dividing them into different waste groups for recycling or combustion.

We recommend that our product is disassembled as much as possible at the disposal and that you try to recycle it. LINAK systems or components should be disposed of in accordance with the environmental regulations applicable in the respective country.

Almost all our cast plastic parts are supplied with an interior code for plastic type and fibre contents, if any.

Servicing double-insulated products

In a double-insulated product, two systems of insulation are provided instead of grounding. No grounding means is provided on a double-insulated product, nor is means for grounding to be added to the product. Servicing a double-insulated product requires extreme care and knowledge of the system, and is to be done only by qualified service personnel. Replacement parts for a double-insulated product must be identical to the parts they replace. A double-insulated product is marked with the words "Double insulation" or "Double insulated." The symbol  (square within a square) can also be marked on the product.

Updated manuals and declarations can always be found at:
<https://www.linak.com/user-manuals/deskline/>.

Accessories and spare parts

Accessories

Order from your nearest LINAK® sales office, distributor or subsidiary.

Spare parts

Please contact your nearest LINAK sales office for information on spare parts.

Contacts

FACTORIES

Denmark - Headquarters
 LINAK A/S
 Phone: +45 73 15 15 15
 Fax: +45 74 45 80 48
 Fax (Sales): +45 73 15 16 13
 Web: www.linak.com

China
 LINAK (Shenzhen) Actuator Systems, Ltd.
 Phone: +86 755 8610 6656
 Phone: +86 755 8610 6990
 Web: www.linak.cn

Slovakia
 LINAK Slovakia s.r.o.
 Phone: +421 51 7563 444
 Web: www.linak.sk

Thailand
 LINAK APAC Ltd.
 Phone: +66 33 265 400
 Web: www.linak.com

USA
 LINAK U.S. Inc.
 Americas Headquarters
 Phone: +1 502 253 5595
 Fax: +1 502 253 5596
 Web: www.linak-us.com
 www.linak-latinamerica.com

SUBSIDIARIES

Australia
 LINAK Australia Pty. Ltd
 Phone: +61 3 8796 9777
 Fax: +61 3 8796 9778
 E-mail: sales@linak.com.au
 Web: www.linak.com.au

Austria
 LINAK Zweigniederlassung - Österreich (Wien)
 Phone: +43 (1) 890 7446
 Fax: +43 (1) 890 744615
 E-mail: info@linak.de
 Web: www.linak.at - www.linak.hu

Belgium
 LINAK Actuator-Systems NV/SA
 (Belgium & Luxembourg)
 Phone: +32 (0)9 230 01 09
 E-mail: beinfo@linak.be
 Web: www.linak.be - www.fr.linak.be

Brazil
 LINAK Do Brasil Comércio De Atuadores Ltda.
 Phone: +55 (11) 2832 7070
 Fax: +55 (11) 2832 7060
 E-mail: info@linak.com.br
 Web: www.linak.com.br

Canada
 LINAK Canada Inc.
 Phone: +1 502 253 5595
 Fax: +1 416 255 7720
 E-mail: info@linak.ca
 Web: www.linak-us.com

Czech Republic
 LINAK C&S s.r.o.
 Phone: +42 058 174 1814
 Fax: +42 058 170 2452
 E-mail: info@linak.cz
 Web: www.linak.cz - www.linak.sk

Denmark - International
 LINAK International
 Phone: +45 73 15 15 15
 E-mail: info@linak.com
 Web: www.linak.com

Denmark - Sales
 LINAK Danmark A/S
 Phone: +45 86 80 36 11
 Fax: +45 86 82 90 51
 E-mail: linak@linak-silkeborg.dk
 Web: www.linak.dk

Finland
 LINAK OY
 Phone: +358 10 841 8700
 E-mail: linak@linak.fi
 Web: www.linak.fi

France
 LINAK France E.U.R.L
 Phone: +33 (0) 2 41 36 34 34
 Fax: +33 (0) 2 41 36 35 00
 E-mail: linak@linak.fr
 Web: www.linak.fr

Germany
 LINAK GmbH
 Phone: +49 6043 9655 0
 Fax: +49 6043 9655 60
 E-mail: info@linak.de
 Web: www.linak.de

India
 LINAK A/S India Liaison Office
 Phone: +91 120 4531797
 Fax: +91 120 4786428
 E-mail: info@linak.in
 Web: www.linak.in

Italy
 LINAK ITALIA S.r.l.
 Phone: +39 02 48 46 33 66
 Fax: +39 02 48 46 82 52
 E-mail: info@linak.it
 Web: www.linak.it

Japan
 LINAK K.K.
 Phone: 81-45-533-0802
 Fax: 81-45-533-0803
 E-mail: linak@linak.jp
 Web: www.linak.jp

Malaysia
 LINAK Actuators Sdn. Bhd.
 Phone: +60 4 210 6500
 Fax: +60 4 226 8901
 E-mail: info@linak-asia.com
 Web: www.linak.my

Netherlands
 LINAK Actuator-Systems B.V.
 Phone: +31 76 5 42 44 40 /
 +31 76 200 11 10
 E-mail: info@linak.nl
 Web: www.linak.nl

New Zealand
 LINAK New Zealand Ltd
 Phone: +64 9580 2071
 Fax: +64 9580 2072
 E-mail: nzsales@linak.com.au
 Web: www.linak.com.au

Norway
 LINAK Norge AS
 Phone: +47 32 82 90 90
 E-mail: info@linak.no
 Web: www.linak.no

Poland
 LINAK Polska
 LINAK Danmark A/S (Spółka Akcyjna)
 Phone: +48 22 295 09 70 /
 +48 22 295 09 71
 E-mail: info@linak.pl
 Web: www.linak.pl

Republic of Korea
 LINAK Korea Ltd.
 Phone: +82 2 6231 1515
 Fax: +82 2 6231 1516
 E-mail: info@linak.kr
 Web: www.linak.kr

Slovakia
 LINAK Slovakia S.R.O.
 Phone: +421 51 7563 444
 Web: www.linak.sk

Spain
 LINAK Actuadores, S.L.U
 Phone: +34 93 588 27 77
 Fax: +34 93 588 27 85
 E-mail: esma@linak.es
 Web: www.linak.es

Sweden
 LINAK Scandinavia AB
 Phone: +46 8 732 20 00
 Fax: +46 8 732 20 50
 E-mail: info@linak.se
 Web: www.linak.se

Switzerland
 LINAK AG
 Phone: +41 43 388 31 88
 Fax: +41 43 388 31 87
 E-mail: info@linak.ch
 Web: www.linak.ch - www.fr.linak.ch
 www.it.linak.ch

Taiwan
 LINAK (Shenzhen) Actuator systems Ltd.
 Taiwan Representative office
 Phone: +886 2 272 90068
 Fax: +886 2 272 90096
 E-mail: sales@linak.com.tw
 Web: www.linak.com.tw

Turkey
 LINAK İth. İhr. San. ve Tic. A.Ş.
 Phone: +90 312 4726338
 Fax: +90 312 4726635
 E-mail: info@linak.com.tr
 Web: www.linak.com.tr

United Kingdom & Ireland
 LINAK UK Limited
 Phone: +44 (0)121 544 2211
 Fax: +44 (0)121 544 2552
 E-mail: sales@linak.co.uk
 Web: www.linak.co.uk

DISTRIBUTORS

Argentina
 Novotec Argentina SRL
 Phone: 011-4303-8989 / 8900
 Fax: 011-4032-0184
 E-mail: info@novotecargentina.com
 Web: www.novotecargentina.com

Colombia
 MEM Ltda
 Phone: +[57] (1) 334-7666
 Fax: +[57] (1) 282-1684
 E-mail: servicioalcliente@memltda.com.co
 Web: www.mem.net.co

India
 Mechatronics Control Equipments India Pvt Ltd
 Phone: +91-44-28558484, 85
 E-mail: bala@mechatronicscontrol.com
 Web: www.mechatronicscontrol.com

Indonesia
 PT. Himalaya Everest Jaya
 Phone: +6 221 544 8956 /+6 221 544 8965
 Fax: +6 221 619 1925
 Fax (Sales): +6 221 619 4658
 E-mail: hejplastic-div@centrin.net.id
 Web: www.hej.co.id

Israel
 NetivTech LTD
 Phone: +972 55-2266-535
 Fax: +972 2-9900-560
 Email: info@NetivTech.com
 Web: www.netivtech.com

Singapore
 Servo Dynamics Pte Ltd
 Phone: +65 6844 0288
 Fax: +65 6844 0070
 E-mail: servodynamics@servo.com.sg

South Africa
 Industrial Specialised Applications CC
 Phone: +27 011 466 0346
 E-mail: gartht@isagroup.co.za
 Web: www.isaza.co.za

United Arab Emirates
 Mechatronics
 Phone: +971 4 267 4311
 Fax: +971 4 267 4312
 E-mail: mechtron@emirates.net.ae

Terms of use

LINAK® takes great care in providing accurate and up-to-date information on its products. However, the user is responsible for determining the suitability of LINAK products for a specific application. Due to continual development, LINAK products are subject to frequent modifications and changes. LINAK reserves the rights to conduct modifications, updates, and changes without any prior notice. For the same reason, LINAK cannot guarantee the correctness and actual status of imprinted information on its products.

LINAK uses its best efforts to fulfil orders. However, for the reasons mentioned above, LINAK cannot guarantee availability of any particular product at any given time. LINAK reserves the right to discontinue the sale of any product displayed on its website or listed in its catalogues or in other written material created and produced by LINAK, LINAK subsidiaries, or LINAK affiliates. All sales are subject to the 'Standard Terms of Sale and Delivery for LINAK A/S' available on LINAK websites. LINAK and the LINAK logotype are registered trademarks of LINAK A/S. All rights reserved.