

Standard (1)

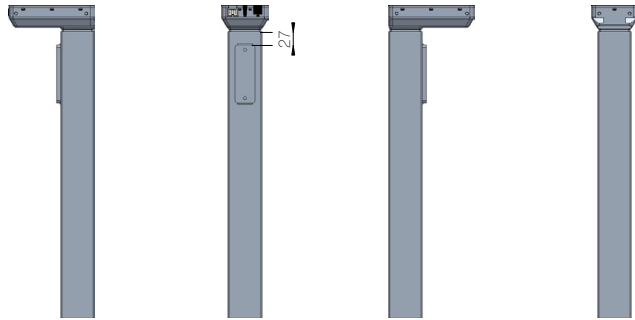

Bench left (L)

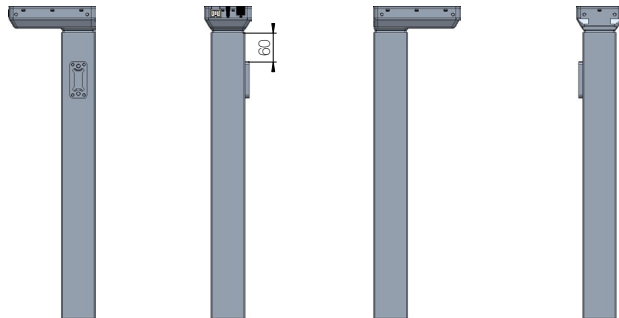

Bench right (R)

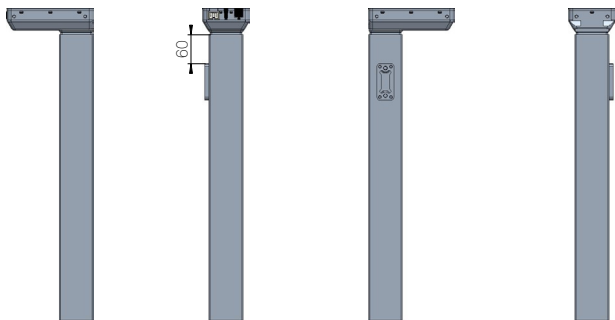

Bracket options, types 1, L and R

DESKLINE Bench left (V)

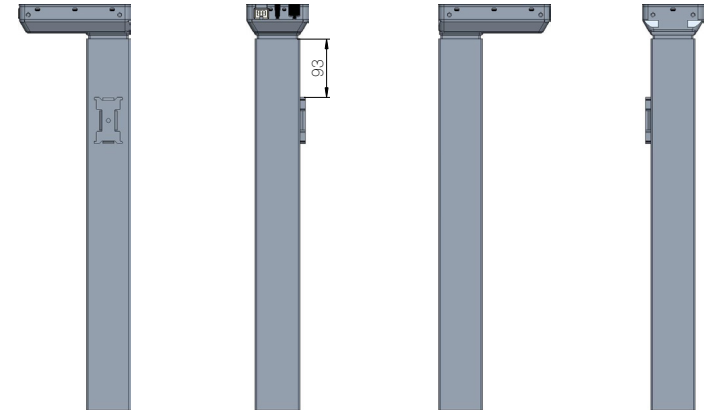

DESKLINE Bench right (H)

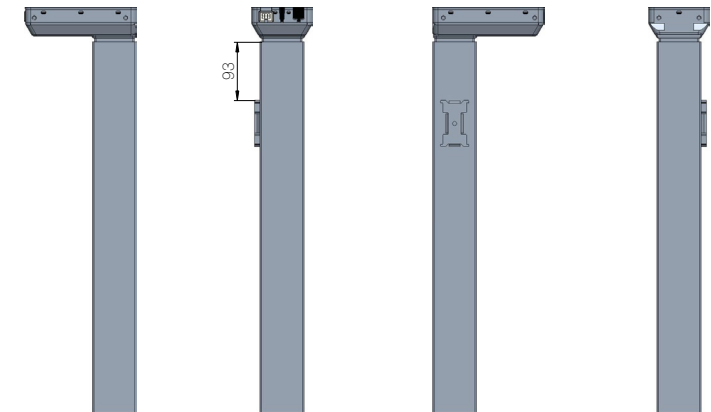

DESKLINE Bench bracket options, types V and H
(Compatible with LINAK cross members)

All rights reserved

Date:

05 March 2026

Description:

DL18
Bracket options

