

# Linear Actuator LA25

## User Manual



## Contents

Preface .....	3
Terms of use .....	4
Introduction.....	5
Safety instructions.....	5
Features.....	7
Options in general .....	7
Usage.....	7
Housing for harsh environments .....	9
Reinforced actuator .....	9
Speed and current curves.....	10
Current limits .....	12
Current cut-offs.....	12
Mounting guidelines.....	13
Dimensions.....	15
Cable mounting.....	16
Electrical installation.....	17
Recommended fuse for power supplies and actuators without integrated controller .....	17
Test of Conducted and Radiated Emission (EMC).....	18
IECEX/ATEX/CCC Ex certified (optional).....	19
Label for LA25 IECE/ATEX/CCC Ex special item.....	20
IECEX/ATEX/CCC Ex certified (optional) .....	21
Warning .....	21
Mounting and replacement of ATEX cables.....	22
Replacing an ATEX cable .....	23
Maintenance .....	25
Repair.....	25
Main groups of disposal.....	25
Warranty .....	25

## Preface

Dear User,

We are delighted that you have chosen a LINAK® product.

LINAK systems are high-tech products based on many years of experience in the manufacture and development of actuators, lifting columns, desk frames, electric control boxes, controls, batteries, accessories and chargers.

This User Manual does not address the end user. It is intended as a source of information for the equipment or system manufacturer only, and it will tell you how to install, use and maintain your LINAK electronics. The manufacturer of the end product has the responsibility to provide a User Manual, where relevant safety information from this manual is passed on to the end user.

We are convinced that your LINAK product/system will give you many years of problem-free operation.

Before our products leave the factory, they undergo both function and quality testing. Should you, nevertheless, experience problems with your product/system, you are always welcome to contact your supplier.

LINAK subsidiaries and some distributors situated all over the world have authorised service centres, which are always ready to help you. Locate your local contact information on the back page.

LINAK provides a warranty on all products. (See warranty section).

This warranty, however, is subject to correct use in accordance with the specifications, maintenance being done correctly, and any repairs being carried out at a service centre, which is authorised to repair LINAK products.

Changes in installation and use of LINAK systems can affect their operation and durability. The products may only be opened by authorised personnel.

This User Manual has been written based on the present technical knowledge. LINAK reserves the right to carry out technical modifications and keeps the associated information updated.

**LINAK A/S**

## Terms of use

LINAK® takes great care in providing accurate and up-to-date information on its products. However, the user is responsible for determining the suitability of LINAK products for a specific application.

Due to continual development, LINAK products are subject to frequent modifications and changes. LINAK reserves the rights to conduct modifications, updates, and changes without any prior notice. For the same reason, LINAK cannot guarantee the correctness and actual status of imprinted information on its products.

LINAK uses its best efforts to fulfil orders. However, for the reasons mentioned above, LINAK cannot guarantee availability of any particular product at any given time. LINAK reserves the right to discontinue the sale of any product displayed on its website or listed in its catalogues or in other written material created and produced by LINAK, LINAK subsidiaries, or LINAK affiliates.

All sales are subject to the 'Standard Terms of Sale and Delivery for LINAK A/S' available on LINAK websites.

LINAK and the LINAK logotype are registered trademarks of LINAK A/S. All rights reserved.

## Introduction

Compact designed linear actuator ideal for narrow spaces. Comes with a high IP degree and aluminium housing and is suited to operate in almost any conditions.

With its robust design, high IP degree and aluminium housing, the actuator LA25 is ideal for harsh environments where operation under extreme conditions is required. Also, it is available with an optional ATEX/IECEX/CCC Ex approval.

## Safety instructions

Please read this safety information carefully.

Be aware of the following three symbols throughout the document:



### Warning!

Failing to follow these instructions can cause accidents resulting in serious personal injury.



### Recommendations

Failing to follow these instructions can result in the actuator suffering damage or being ruined.



### Additional information

Usage tips or additional information that is important in connection with the use of the actuator.

Furthermore, ensure that all staff who are to connect, mount, or use the actuator are in possession of the necessary information and that they have access to this document.

Persons who do not have the necessary experience or knowledge of the product/products must not use the product/products. Besides, persons with reduced physical or mental abilities must not use the product/products, unless they are under surveillance or they have been thoroughly instructed in the use of the apparatus by a person who is responsible for the safety of these persons.

Moreover, children must be under surveillance to ensure that they do not play with the product.

### **Before you start mounting/dismounting, ensure that the following points are observed:**

- The actuator is not in operation.
- The actuator is free from loads that could be released during this work.

### **Before you put the actuator into operation, check the following:**

- The actuator is correctly mounted as indicated in the relevant user instructions.
- The equipment can be freely moved over the actuator's whole working area.
- The actuator is connected to a mains electricity supply/transformer with the correct voltage and which is dimensioned and adapted to the actuator in question.
- Ensure that the voltage applied matches to the voltage specified on the actuator label.
- Ensure that the connection bolts can withstand the wear.
- Ensure that the connection bolts are secured safely.

**During operation, please be aware of the following:**

- Listen for unusual sounds and watch out for uneven running. Stop the actuator immediately if anything unusual is observed.
- Do not sideload the actuator.
- Only use the actuator within the specified working limits.
- Do not step on or kick the actuator.

**When the equipment is not in use:**

- Switch off the mains supply in order to prevent unintentional operation.
- Check regularly for extraordinary wear.

**Classification**

The equipment is not suitable for use in the presence of a flammable anaesthetic mixture with air or with oxygen or nitrous oxide.

**Warnings**

- Do not sideload the actuator.
- When mounting the actuator in the application ensure that the bolts can withstand the wear and that they are secured safely.
- If irregularities are observed, the actuator must be replaced.
- The actuator is not to be opened by unauthorised personnel. In case the actuator is opened, the warranty will be invalid.

**Recommendations**

- Do not place load on the actuator housing.
- Prevent impact or blows, or any other form of stress to the housing.
- Ensure that the cable cover is mounted correctly. Use 1 Nm torque.
- Ensure that the duty cycle and the usage temperatures for LA25 actuators are respected.
- Ensure that the cable cannot be squeezed, pulled or subjected to any other stress.
- Furthermore, it will be good practice to ensure that the actuator is fully retracted in the “normal” position. The reason is that there will be a vacuum inside the actuator if it is extended which over time can lead to water entering the actuator.

## Features

- Protection class: IP66 for outdoor use (dynamic). Furthermore, the actuator can be washed down by a high pressure cleaner (IP69K - static)
- Heavy-duty aluminium housing for harsh conditions
- Mechanical endstop
- Guided nut
- Static safety factor: 2.0
- Noise level: Max. 58.5 dB (A) at nominal voltage and with no load, according to EN ISO 3743-1
- Weight: 1.42 kg for 100 mm stroke; additional 0.09 kg for each additional 50 mm stroke. (Cable not included; weight varies by selected options)

## Options in general

- 12 / 24 V DC Brushed motor
- Load up to 2,500 N
- Max. speed 2.5 to 25 mm/sec. depending on load and spindle pitch
- Stroke length from 20 mm to 600 mm (Zero Point: 75 to 600 mm)
- Various back fixtures and piston rod eyes in stainless and zinc-coated steel
- Back fixture available in 2 different positions: 0° or 90°
- Colour: Dark olivish grey or black (Harsh environment housing)
- Safety nut in push or pull (2,500 N version: only safety nut in push; 600 N version: no safety nut)
- Exchangeable cables in different lengths up to 10 m
- Analogue or digital feedback for precise positioning
- Endstop reached signals
- Built-in Zero Point or endstop switch initialisation principle
- Hall effect sensor for precise positioning
- Special anodised housing for extreme environments
- CCC Ex, IECEx/ATEX certified for Zone 21\*
- IC options (see specific interface user manuals at the [TECHLINE webpage](#) for Connection Diagrams and I/O Specifications) including:
  - I/O
  - IO-Link
  - LIN bus
  - CAN bus J1939
  - CANopen
  - Modbus RTU
  - Modbus TCP/IP
  - EtherNet/IP
  - Profinet
- PC configuration tool (Actuator Connect™ and BusLink)



For more information about interfaces, please see the respective user manual on LINAK.com.

\* Only available for actuators with 8-pin connector.

## Usage

- Duty cycle is max. 20% (4 min. drive and 16 min. rest)  
The duty cycles and full performance are valid for operation within an ambient temperature of +5°C to +40°C

**Please note:** For actuators with short stroke length, low load, and infrequent operation where running time is critical, variations in running time may occur over time.  
To ensure the optimal solution for your application, contact LINAK A/S.

- Ambient operating temperature: -40°C to +85°C (for IECEx/ATEX/CCC Ex: T135 -25°C to +65°C; IECEx/ATEX: T125 -25°C to +55°C )
- Storage temperature: -55°C to +105°C

## Housing for harsh environments

This housing (ordering example value IP: 9) should be recommended for use in particularly harsh environments such as stables, where the actuator is in touch with extremely corrosive liquids and/or vapours such as ammoniac.

The anodised housing option embodies a special surface treatment of the aluminium housing in order to reduce corrosion of the housing and avoid any vapours or liquids entering the actuator.

The anodised housing is also certified IP66/IP69K. This is only available in the colour black.

## Reinforced actuator



This type of actuator (ordering example value IP: C and D) is robust against vibrations and high ambient temperatures up to 85°C.

When ordering this type of actuator, you receive:

- Manually added glue on the screws for the outer tube and motor
- A motor wire manually secured with glue
- A back fixture secured with an M27 nut

The reinforced design enables the actuator to pass the TECHLINE® vibration test at an ambient temperature of 85°C\*.

A standard actuator passes the TECHLINE vibration test at an ambient temperature of 25°C.

\* See more info under 'Environmental tests - Mechanical'.

## Speed and current curves

The charts below display typical values made with a nominal power supply and an ambient temperature of 20°C.

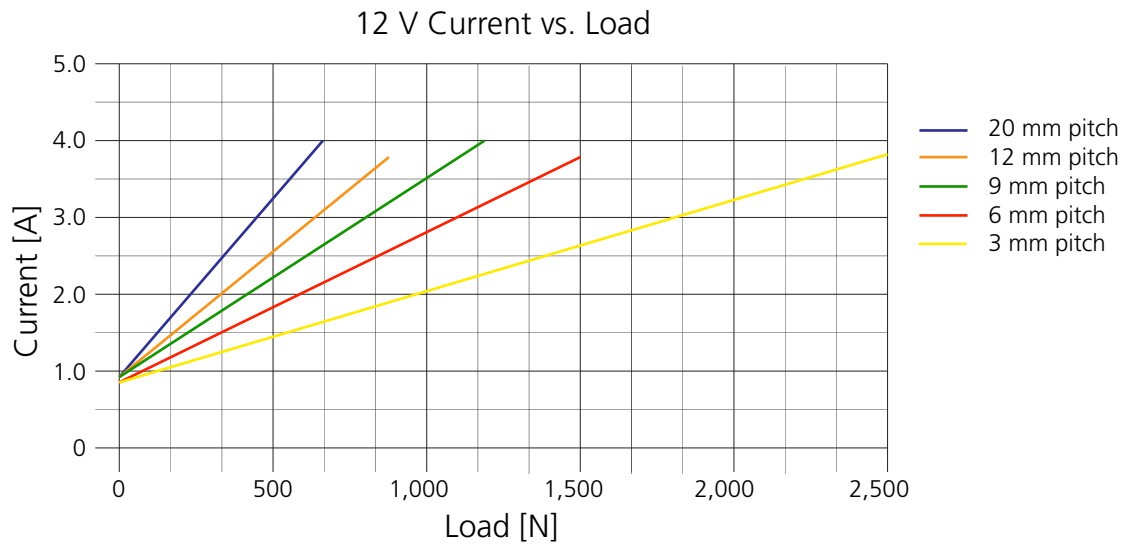
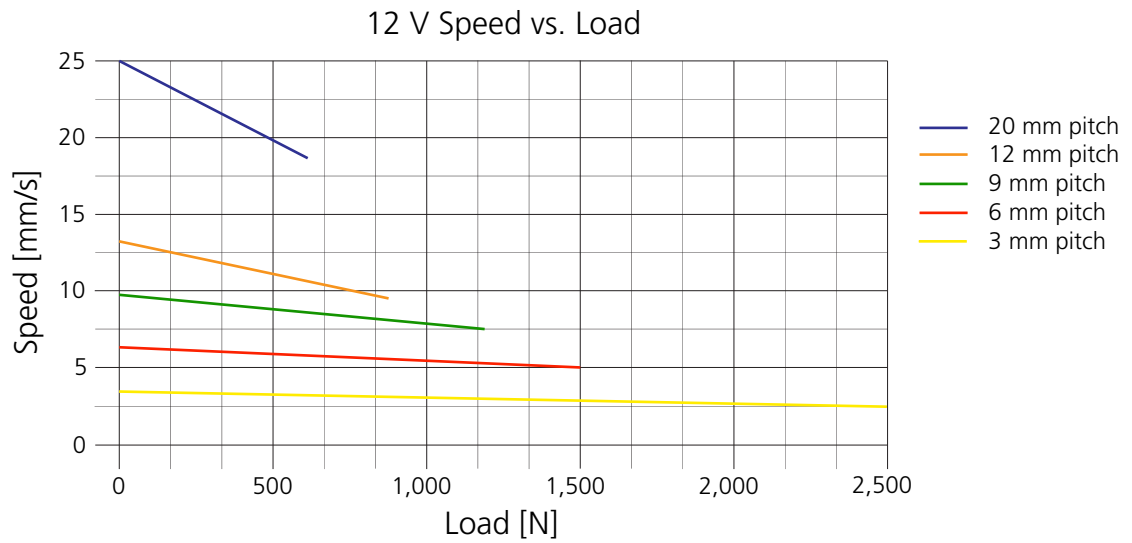

## Speed and current curves

The charts below display typical values made with a nominal power supply and an ambient temperature of 20° C.

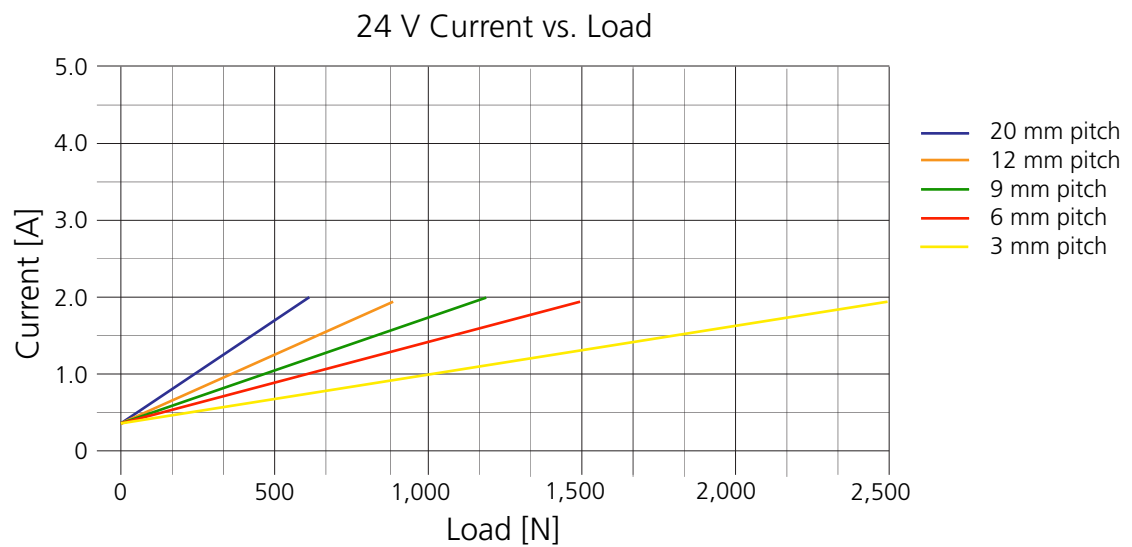
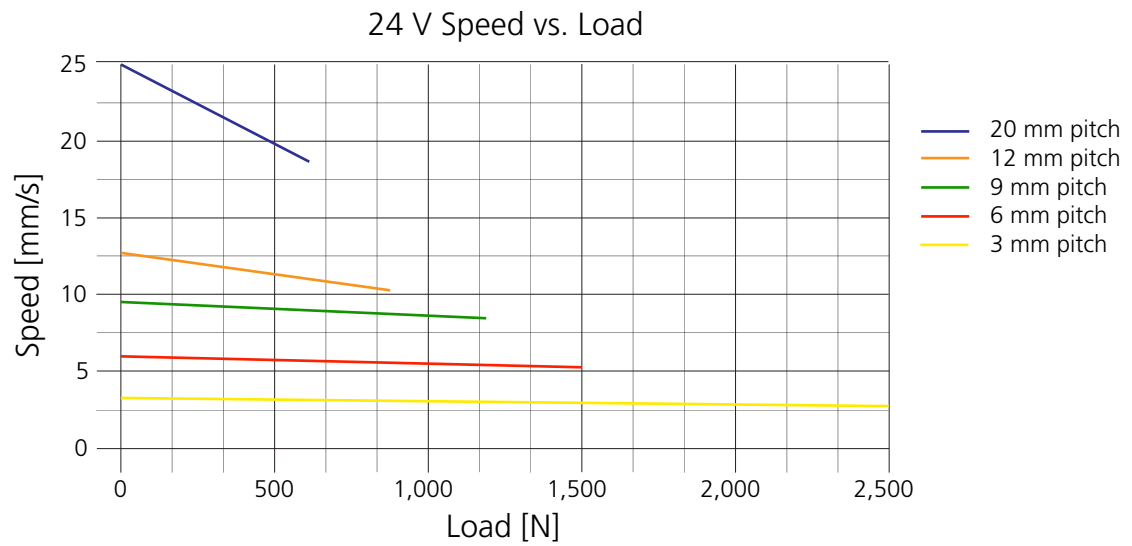

## Current limits

If the actuator's current consumption rises above the set limit, the actuator regulates and tries to keep it below the set current limit by reducing the PWM and therefore also the speed accordingly. The actuator does this continuously, until the actuator stops moving (mechanically blocked). If there are no changes to the Hall feedback signal during the set time frame, the integrated controller will cut power to the H-bridge motor circuit.

If the actuator is stopped due to the above-mentioned criteria, it automatically drives slightly in the opposite direction to reduce the torque in a blocking situation.

For more detailed information, please see the I/O interface manual.

Platform		12 V	24 V	Reference temperature: 0°C
A B C E F G	IO-Link (8-pin) I/O Basic I/O Customised EtherNet/IP I/O Full CAN bus J1939	8 A	5 A	Above
H P Q S T	CANopen PROFINET Modbus RTU IO-Link (12-pin) Modbus TCP/IP	9 A	6 A	Below

## Current cut-offs

The principle behind the current cut-off measurement is an 'above limit' and a 'below limit' accumulating counter. When the time-out counter reaches a specific value the current cut-off goes into effect. The time-out value is pre-set at 500 ms.

Platform		12 V	24 V	Reference temperature: 0°C
3 6	IC (Not for OpenBus™) LIN bus	8 A	5 A	Above
7 9	CAN bus J1939 CANopen	8 A	8 A	Below

## Mounting guidelines

LINAK® linear actuators are quickly and easily mounted by slipping pins through the holes on each end of the units and into brackets on the machine frame and the load.

The mounting pins must be parallel to each other as shown in Figure 1. Pins, which are not parallel to each other, may cause the actuator to bend and be damaged.

The load should act along the stroke axis of the actuator as off-centre loads may cause bending and lead to premature failure. See Figure 2.

Make sure the mounting pins are supported in both ends. Failure to do so could shorten the life of the actuator. Also, avoid applying a skewed load on the actuator.

Fig. 1

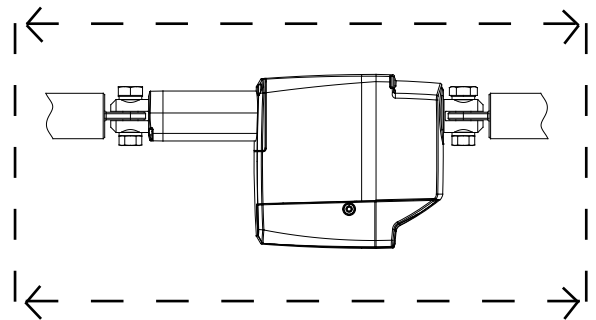

The actuator can rotate around the pivot point in the front and rear end. If this is the case, it is of high importance that the actuator is able to move freely over the full stroke length, both during the development and daily operation. Please pay special attention to the area around the housing where parts can be trapped and cause damage to the application and actuator.

In applications with high dynamic forces, LINAK recommends not to use the fully extended or retracted position over longer time, as this can damage the endstop system permanently.

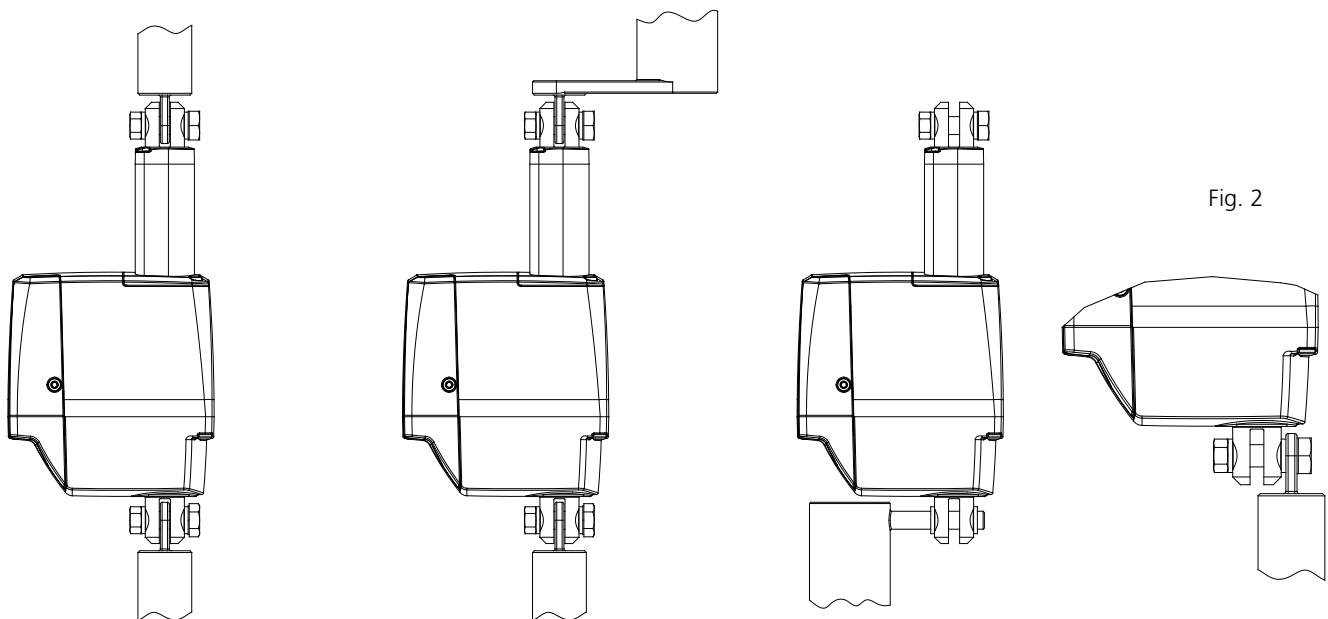

Fig. 2

Right

Wrong

Wrong

Wrong

## Mounting guidelines



- The mounting pins must have the correct dimension
- The bolts and nuts must be made of a high quality steel grade (min. 8.8). No thread on the bolt inside the back fixture or the piston rod eye.
- Bolts and nuts must be secured so there is no risk for them to fall out.
- Do not use a torque that is too high when mounting the bolts for the back fixture or the piston rod eye. This will stress the fixtures.

**Please note:** The piston rod eye is only allowed to turn 0-180 degrees.



### **Instruction concerning the turning of the piston rod eye and inner tube:**

- When mounting and taking into use, it is not permitted to make excessive turns of the piston rod eye. In cases where the eye is not positioned correctly, it is permitted to:
  1. Screw the eye down to its bottom position at a max. torque of 2 Nm clockwise (1)
  2. And thereafter a max. 180° turn out again (2).
- As the piston rod eye can turn freely, it is important to ensure that the eye cannot rotate if the actuator is used in a pull application. If this happens, the actuator will be pulled apart.

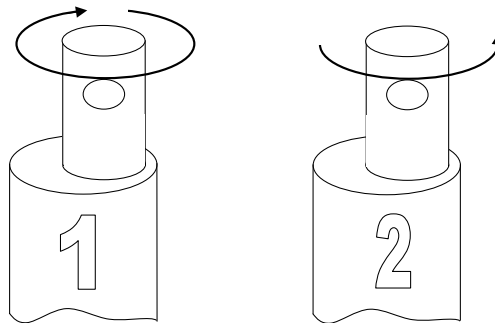

### **Warning!**

If the actuator is used in an application where personal injury can occur, it is the application manufacturer's responsibility to incorporate a suitable safety arrangement, which will prevent personal injury from occurring, if the actuator should fail.

## Dimensions

All dimensions are in mm

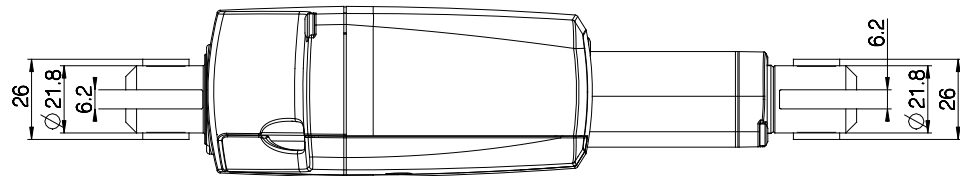
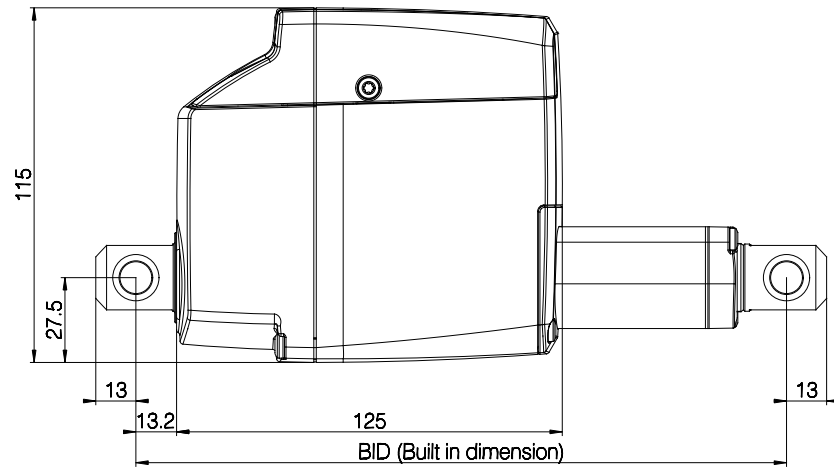
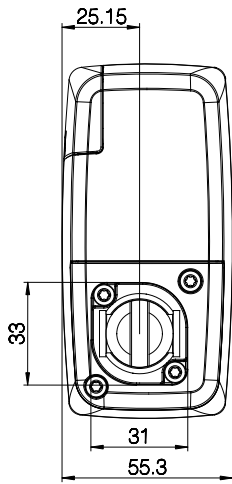

## Cable mounting

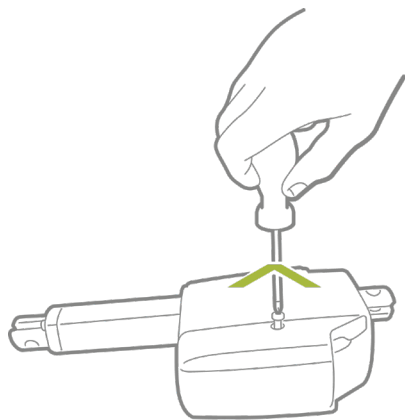

1. Unscrew the cover

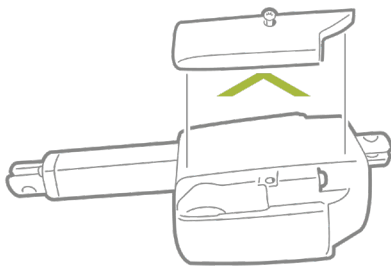

2. Remove the cover and blind plug

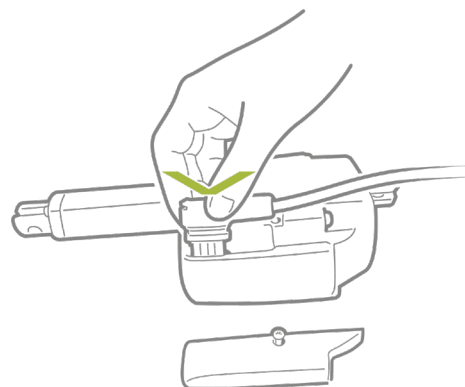

3. Plug in the cable gently without using any tools

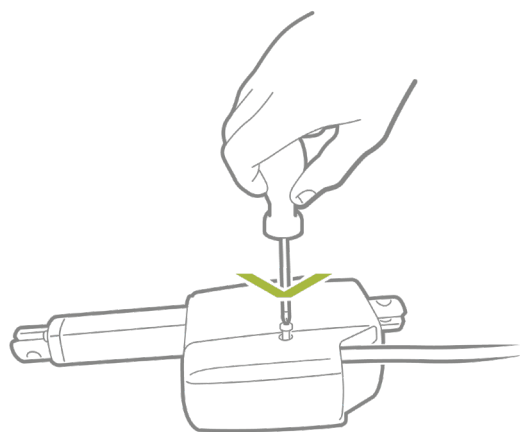

4. Screw the cover back onto the actuator

The torque of the cover screw is approx. 1 Nm

## Removing cables

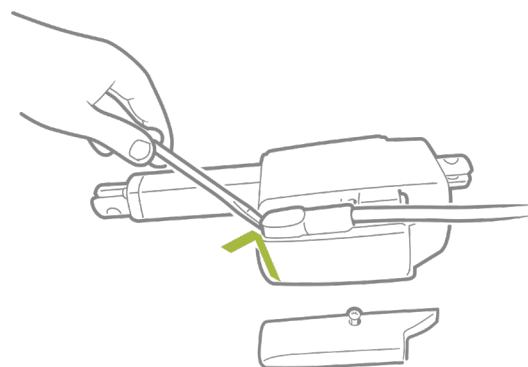

5. Use a screwdriver to pull up the cable



When changing the cables on a LINAK® actuator, it is important that this is done carefully, in order to protect the plugs and pins. Before the new cable is mounted, we recommend that the socket is greased with Vaseline®, to keep the high IP protection and ensure an easy mounting. Please be sure that the plug is in the right location and fully pressed in before the cable lid is mounted.

Please note that if the cables are mounted and dismantled more than 3 times the plugs can be damaged. Therefore, we recommend that such cables are discarded and replaced.

Also note that the cables should not be used for carrying the actuator.

We recommend to take some precaution and design the wire connection in a way, where the cable end is kept inside a closed, protected area to guarantee the high IP protection.



**NOT** valid for ATEX cables, please refer to the ATEX section for correct cable mounting on ATEX actuators.

## Electrical installation



- To ensure maximum self-locking ability, please be sure that the motor is shorted when stopped. Actuators with integrated controller provide this feature, as long as the actuator is powered.
- When using soft stop on a DC-motor, a short peak of higher voltage will be sent back towards the power supply. It is important when selecting the power supply that it does not turn off the output, when this backwards load dump occurs.
- When using actuators without integrated controller, it is strongly recommended to use a fuse between power supply and actuator.



The power supply for actuators without integrated controller must be monitored externally and cut off in case of current overload.

### Recommended fuse for power supplies and actuators without integrated controller

Platform		Spindle pitch (mm)	Load max. Push/Pull (N)	Typical amp. at full load (A)		Recommended fuse	
				24 V	12 V	24 V	12 V
0	None with built-in limit switches	3	2,500	1.9	3.8	3 A	6 A
		6	1,500	1.9	3.8	3 A	6 A
		9	1,200	2.0	4.0	3 A	6 A
		12	900	1.9	3.8	3 A	6 A
		20	600	2.0	4.0	3 A	6 A

## Test of Conducted and Radiated Emission (EMC)

All TECHLINE® actuators have been tested in accordance with EN55011 class B (2007) (CISPR 11). A 1 m cable has been used in the test set-up.

### Actuator without H-Bridge

1) For normal operation the following is valid:

- Radiated emission requirements are met.
- Conducted emission requirements are met. However, to meet with these requirements, a capacitor has been mounted across the motor wires outside the actuator, and tests have then been made with this capacitor. Capacitor values for some of the TECHLINE actuators can be found in the scheme below

To comply with EN55011 class B (2007) a capacitor must be added across the motor wires, or the connected control box must have similar/better filtering. The actuator is not delivered with a built in capacitor, because then it would not be possible to PWM the motor.

Please view the scheme below for the correct choice of capacitor for the actuator in question:

Product	Capacitor value
LA25	1 $\mu\text{F}$

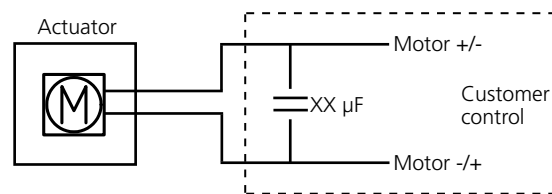

2) For systems/operations that use PWM-control it is up to the customer to test and meet the requirements.

### Actuator with H-Bridge

1) For normal operation with soft start/stop the following is valid:

- The actuator has been tested when operating with constant 80%-PWM.
- Radiated emission requirements are met.
- Conducted emission requirements are met.

2) For systems with LINAK® PWM regulation (among other things Parallel operation and speed regulation) the following is valid:

- Radiated emission requirements are met.
- Conducted emission requirements are met.

3) Speed regulation:

- If the speed is regulated below a nominal speed of 80% (80% PWM), it is necessary to mount a filter in order to comply with the conducted emission requirements. For systems/operations that are speed regulated, it is up to the customer to test and meet the requirements

## IECEX/ATEX/CCC Ex certified (optional)

LA25 can be ordered as an Ex certified version designed for installation in dust-filled atmospheres such as grain handling facilities, cement plants, saw mills or other dusty surroundings.



Please note: This approval is only valid for dusty environments, NOT for gas.

The IECEX/ATEX versions are suitable for applications in Group IIIC, Category 2D. Zone 21 and 22. Certified according to EN60079-0:2018 and EN60079-31:2014.

The CCC Ex version is designed to be used in group IIIC tb T135°C Db and certified according to CNCA-C23-01:2024, in accordance to the GB/T 3836.1-2021 and GB/T 3836.31-2021 standards.



**LINAK**

Designed in Denmark  
DK - 6430 Nordborg

Type : 25XXXXXXXXXXXXT=XXXXXXXXXXXX  
Item No. : JXXXXX / 25XXX-XX  
Prod. Date : 2024.02.01  
Max Load : Push xxxx N / Pull xxxx N IP66  
Power Rate: xx V $\bar{=}$ , Max. xx A  
Duty Cycle : 20% Max. 4 min/16 min

NOT TO BE OPENED BY UNAUTHORIZED PERSONNEL  
NE PAS OUVRIR PAR DU PERSONNEL NON AUTORISE

W/O #-0001 Made in Denmark  
CE 2804 II 2D

Ex tb IIIC T135°C Db  
Tamb -25°C to +65°C  
Certificate no.: TÜV 15 ATEX 143744 X  
IECEX TUN 14.0020X

**WARNING !**

DO NOT OPEN WHEN AN EXPLOSIVE ATMOSPHERE IS PRESENT.  
DO NOT SEPARATE WHEN ENERGISED.  
DO NOT OPEN WHEN ENERGISED.  
POTENTIAL ELECTROSTATIC CHARGING HAZARD :  
SEE INSTRUCTIONS !

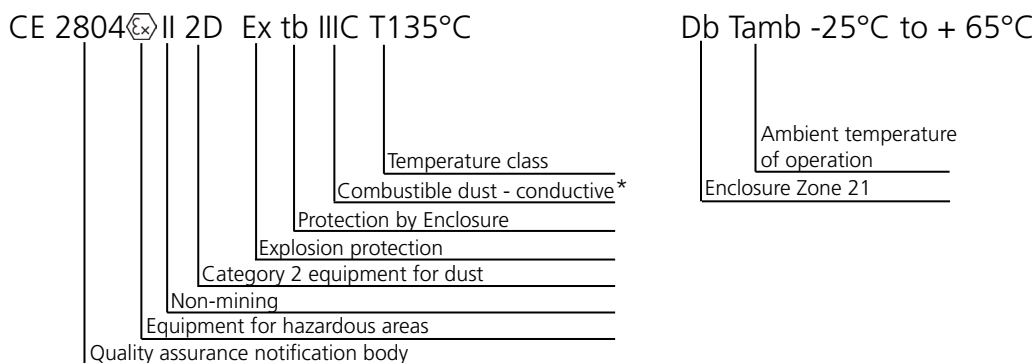

\* Not a source of ignition in normal operation or when subjected to faults that may be expected, though not on a regular basis.

## Label for LA25 IECE/ATEX/CCC Ex special item

LA25 can be ordered as an Ex certified version designed for installation in dust-filled atmospheres such as grain handling facilities, cement plants, saw mills or other dusty surroundings, but in lower ambient temperatures as with the standard Ex approval.



Please note: This approval is only valid for dusty environments, NOT for gas.

The IECEx/ATEX versions are suitable for applications in Group IIIC, Category 2D. Zone 21 and 22. Certified according to EN60079-0:2018 and EN60079-31:2014.

The CCC Ex version is designed to be used in group IIIC tb T135°C Db and certified according to CNCA-C23-01:2024, in accordance to the GB/T 3836.1-2021 and GB/T 3836.31-2021 standards.



**LINAK**

Designed in Denmark  
DK - 6430 Nordborg

Type : 25XXXXXXXXXXXXT=XXXXXXXXXXXX  
Item No. : 25XXX-XX.  
Prod. Date : 2024.02.29  
Max Load : Push xxxx N / Pull xxxx N IP66  
Power Rate: xx V~, Max. xx A  
Duty Cycle : 20% Max. 4 min/16 min

NOT TO BE OPENED BY UNAUTHORIZED PERSONNEL  
NE PAS OUVRIR PAR DU PERSONNEL NON AUTORISE

W/O #-0001 Made in Denmark

CE 2804 II 2D  
Ex tb IIIC T125°C Db  
Tamb -25°C to +55°C  
Certificate no.: TÜV 15 ATEX 143744 X  
IECEX TUN 14.0020X

**WARNING !**

DO NOT OPEN WHEN AN EXPLOSIVE ATMOSPHERE IS PRESENT.

DO NOT SEPARATE WHEN ENERGISED.

DO NOT OPEN WHEN ENERGISED.

POTENTIAL ELECTROSTATIC CHARGING HAZARD : SEE INSTRUCTIONS !

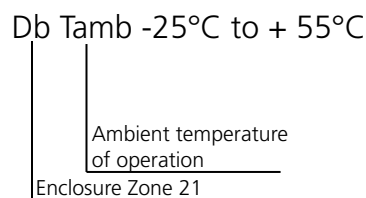
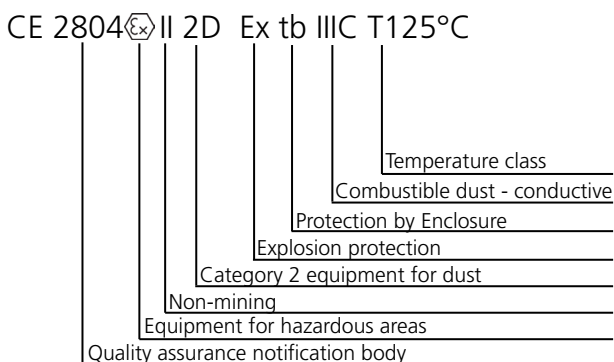

## IECEX/ATEX/CCC Ex certified (optional)

The IECEX/ATEX/CCC Ex versions are suitable for applications in Group IIIC, Category 2D. E.g. Zone 21 and 22 with the following markings:

IECEX: EX tb IIIC T135°C dB

IECEX: EX tb IIIC T125°C dB

ATEX: II 2D Ex tb IIIC T135°C dB

ATEX: II 2D Ex tb IIIC T125°C dB

CCC Ex: Ex tb T135°C dB



### Special conditions for use as stated in the certificates:

1. The max duty cycle is specified at an ambient temperature of +25°C.  
The duty cycle is max. 20% (2 min continuous drive followed by 8 min rest).
2. Ambient temperature area are specified to -25 °C +65 °C. (Max. +55°C for T125°C)
3. The power supply cable is of special design fulfilling IP 6X ingress protection. The cable can be delivered in different lengths. Only cables delivered by LINAK A/S shall be mounted.
4. The connection between the actuator and the rest of the machine/device shall be conductive, and furthermore the application shall be grounded in order to remove any Electro Static Discharge. This counts for both of the actuator's fixation points (Back Fixture and Piston Rod Eye).
5. The cable is not UV-resistant and shall be protected from direct sunlight.
6. The supply has to be protected by a fuse according to the electrical data.
7. The Linear Actuator has to be installed in such a way, that highly effective potential electrostatic charges are prevented. The cleaning of the Linear Actuator shall be done only with a damp cloth.

## Warning

**If the following is not complied with, the IECEX/ATEX/CCC Ex certification will not be valid:**

- Actuator use must be in compliance with specification.
- If the actuator has no built-in current cut-off, one must be mounted (Please see the Max current on the type-plate placed on the actuator)
- Only IECEX/ATEX/CCC Ex approved cables are to be used:

Cable type	No. of wires in cable	LA25 IECEX/ATEX/CCC Ex cable	Cable length (mm)
Power and signal	8 Pins 6 x 20 AWG + 2 x 18 AWG	0147006-xxxx	850 / 1,600 / 5,000 mm
Power and signal	11 Pins 9 x 20 AWG + 2 x 18 AWG	0257084-xxxx	1,650 / 5,150 mm

- The power supply/signal cables for the actuator must be terminated in a safe location or alternatively by use of an Ex terminal box certified for special conditions for safe use.
- When mounting or if changing cables in IECEX/ATEX/CCC Ex approved applications, the standard EN IEC 60079-19 must be respected to maintain the certification. It is crucial that a proper tightness is obtained after installing/replacing the cables, therefore the installation guideline below must be strictly followed.
- The actuator is not to be opened in areas with dust, and unauthorized personnel is never to produce, modify or repair actuators in order to sustain the approval.
- No changes are to be made to the actuator after delivery. This manual is part of the equipment. LINAK A/S keeps the right to modify specifications without advanced notice. Spare this manual for later use.

**The product may only be used if:**

1. The product is used under the conditions described in the installation - and operation instruction
2. Special conditions for safe use are obtained (see above)
3. Atmospheric conditions: Pressure 80 kPa (0.8 bar) to 110 kPa (1.1 bar); and air with normal oxygen content, typically 21% v/v
4. Safety and operation instructions are accessible and followed
5. The production of IECEx/ATEX/CCC Ex actuators require quality management systems and auditing. Therefore, only LINAK A/S is allowed to produce, modify or repair actuators in order to sustain the certification.

**IECEx/ATEX/CCC Ex****General indication of risk:**

Installation of the device shall be performed by trained staff only, familiar with the safety requirements and risks. The installation shall be according to EN IEC 60079-14 and all local safety regulations shall be complied with.

Prevent failures, protect persons against injuries and protect the device against damage.

The person responsible for the system must secure that:

- Safety and operation instructions are accessible and followed
- Local safety regulations and standards are obeyed
- Performance data and installation specifications are complied with
- Safety devices are installed correctly and recommended maintenance is performed
- National regulations for disposal of electrical equipment are obeyed

**Maintenance and repair**

- Repairs of the device must be carried out by LINAK® authorized persons only or by authorised repair shop fulfilled EN IEC 60079-19
- Only perform mounting as described as in this manual

During maintenance regard all safety regulations and internal operation instructions.

**Mounting and replacement of ATEX cables**

When mounting the necessary ATEX-approved cables on an ATEX certified LINAK actuator, it is important that this is done carefully by a competent person, in order to protect the plugs and pins -and ensuring the ingress protection of the product. Before the new cable is mounted, the socket shall be greased with Vaseline®, to maintain the high ingress protection and ensuring easy mounting. The plug shall be in the right location and fully pressed in before the cable lid is mounted.

Please note that if the cables are mounted and dismantled more than 3 times the plugs can be damaged. Therefore, such cables shall be discarded and replaced.

Also note that the actuator must not be carried in the cables.

We recommend to take some precaution and design the wire connection in a way, where the cable end is kept inside a closed, protected area to guarantee the high IP protection.

## Replacing an ATEX cable



Loosen the screw to disassemble the cable relief.



Remove the cable relief by pulling it in the same direction as the screw.



Remove the plugged cable.



Insert the cable (0147006-xxxx or 0257084-xxxx) with an ATEX-approved O-ring.

The colour of the O-ring must be **Brown**.

## Replacing an ATEX cable



### Correct mounting of cable

The brown O-ring is not visible.



### Incorrect mounting of cable

The brown O-ring is visible and the application is NOT tight.

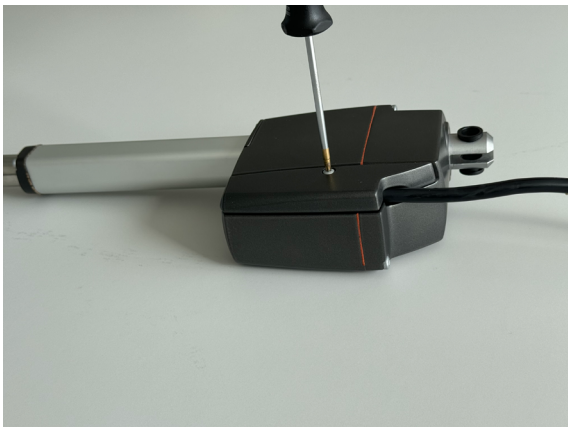

Place the cable relief on the actuator housing, then place and tighten the screw.

Fasten it to  $1 \text{ Nm} \pm 0,5 \text{ Nm}$

## Maintenance

- The actuator must be cleaned at regular intervals to remove dust and dirt, and it must be inspected for mechanical damages or wear.
- Inspect attachment points, wires, piston rod, cabinet, and plug. Also check whether the actuator functions correctly.
- To ensure that the pre-greased inner tube remains lubricated, the actuator must only be washed down when the piston rod is fully retracted.
- The actuator is a closed unit and therefore requires no internal maintenance.
- In order to maintain a proper performance of the spherical eyes and to increase the resistance against environmental wear, we strongly recommend that the spherical eyes (ball bearings) mounted on actuators from LINAK® are greased with anticorrosive grease or similar.

## Repair

See warranty disclaimer.

## Main groups of disposal

LINAK's products may be disposed of, possibly by dividing them into different waste groups for recycling or combustion.

We recommend that our product is disassembled as much as possible at the disposal and that you try to recycle it.

Product	Metal scrap	Cable scrap	Electronic scrap	Plastic recycling or combustion
LA25	X	X	X	X

## Warranty

There is an 18 months' warranty on TECHLINE® products against manufacturing faults starting from the production date of the individual products (see label). LINAK's warranty is only valid in so far as the equipment has been used and maintained correctly and has not been tampered with. Furthermore, the actuator must not be exposed to violent treatment. In the event of this, the warranty will be ineffective/invalid. For further details, please see standard terms of sale and delivery for LINAK A/S.

### Note

Only an authorised LINAK service centre should repair LINAK actuator systems. Systems to be repaired under warranty must be sent to an authorised LINAK service centre.

In order to avoid the risk of malfunction, all actuator repairs must only be carried out by an authorised LINAK Service shop or repairer, as special tools and parts must be used.

If a system is opened by unauthorised personnel there is a risk that it may malfunction at a later date.

The actuator is not to be opened by unauthorised personnel. In case the actuator is opened, the warranty will be invalid.



## DECLARATION OF CONFORMITY

LINAK A/S  
Smedevænget 8  
DK - 6430 Nordborg

Hereby declares that

Actuator 25\*\*\*\*\*0\*\*\*\*\*  
25\*\*\*\*\*3\*\*\*\*\*  
25\*\*\*\*\*CD\*\*\*\*\*

(The "\*"s in the product description can either be a character or a number, thereby defining the variation of the product)

complies with the EMC Directive: 2014/30/EU according to following harmonized standards:  
EN 61000-6-1:2019, EN 61000-6-3:2021, EN 61000-6-2:2019, EN 61000-6-4:2019

complies with the ATEX Directive 2014/34/EU according to following standards:  
EN IEC 60079-0:2018, EN 60079-31:2014  
TÜV NORD CERT GmbH, Notified Body No. 0044. Certificate Number TÜV 15 ATEX 143744 X

NOTE: Applies only for ATEX specified actuators. Marking plate shows the CE-ATEX approval marking.

complies with the RoHS2 Directive 2011/65/EU according to the standard:  
EN IEC 63000:2018

Nordborg, 2025-03-06

**LINAK A/S**  
John Kling, B.Sc.E.E.  
Certification and Regulatory Affairs  
Authorized to compile the relevant technical documentation

This declaration of conformity is issued under the sole responsibility of the manufacturer.

Original declaration



## DECLARATION OF CONFORMITY

LINAK A/S  
Smedevænget 8  
DK - 6430 Nordborg

Hereby declares that

Actuator (LA25IO) 25\*\*\*\*\*B\*\*\*=\*\*\*\*\*, 25\*\*\*\*\*C\*\*\*=\*\*\*\*\*,  
25\*\*\*\*\*F\*\*\*=\*\*\*\*\*

(The '\*' in the product description can either be a character or a number, thereby defining the variation of the product)

complies with the Radio Equipment Directive (RED) 2014/53/EU according to following standards:

EN 300 328 V2.2.2. (2019-07)  
EN 301 489-1 V2.2.3 (2019-11)  
EN 301 489-17 V3.2.4 (2020-09)  
EN 62479:2010  
EN 50663:2017  
EN 60335:2012 + A1, A11, A13, A14, A15, A16  
EN62233:2008

complies with the ATEX Directive 2014/34/EU according to following standards:

EN IEC 60079-0:2018, EN 60079-31:2014  
TÜV NORD CERT GmbH, Notified Body No. 0044. Certificate Number TÜV 15 ATEX 143744 X

NOTE: Applies only for ATEX specified actuators. Marking plate shows the CE-ATEX approval marking.

complies with the RoHS2 Directive 2011/65/EU according to the harmonised standard:

EN 63000:2018

Additional information:

The system does comply with the selected parts of the standards:

EN IEC 61000-6-2:2019, Electromagnetic compatibility (EMC) – Part 6-2: Generic standards – Immunity for industrial environments  
EN IEC 61000-6-4:2019: Electromagnetic compatibility (EMC) – Part 6-4: Generic standards – Emission standard for industrial environments

Nordborg, 2025-03-06

**LINAK A/S**  
John Kling, B.Sc.E.E.  
Regulatory Affairs Manager  
Authorized to compile the relevant technical documentation

This declaration of conformity is issued under the sole responsibility of the manufacturer  
Original Declaration



## DECLARATION OF CONFORMITY

LINAK A/S  
Smedevænget 8  
DK - 6430 Nordborg

Hereby declares that

Actuator (LA25 CAN) 25\*\*\*\*\*6A\*\*\*\*\*; 25\*\*\*\*\*6B\*\*\*\*\*  
25\*\*\*\*\*7A\*\*\*\*\*; 25\*\*\*\*\*7B\*\*\*\*\*  
25\*\*\*\*\*9A\*\*\*\*\*; 25\*\*\*\*\*9B\*\*\*\*\*

(The '\*' in the product description can either be a character or a number, thereby defining the variation of the product)

complies with the EMC Directive 2014/30/EU according to following harmonised standards:  
EN 61000-6-1:2019, EN 61000-6-2:2019, EN 61000-6-3:2021, EN 61000-6-4:2019

complies with the ATEX Directive 2014/34/EU according to following standards:  
EN IEC 60079-0:2018, EN 60079-31:2014  
TÜV NORD CERT GmbH, Notified Body No. 0044. Certificate Number TÜV 15 ATEX 143744 X

NOTE: Applies only for ATEX specified actuators. Marking plate shows the CE-ATEX approval marking.

complies with the RoHS2 Directive 2011/65/EU according to the harmonised standard:  
EN 63000:2018

Nordborg, 2025-03-06

**LINAK A/S**  
John Kling, B.Sc.E.E.  
Regulatory Affairs Manager  
Authorized to compile the relevant technical documentation

This declaration of conformity is issued under the sole responsibility of the manufacturer

Original Declaration



## DECLARATION OF CONFORMITY

LINAK A/S  
Smedevænget 8  
DK - 6430 Nordborg

Hereby declares that

Actuator (LA25IO-Link) 25\*\*\*\*\*00AB\*\*=\*\*\*\*\*0\*00\*\*\*

(The "\*" in the product description can either be a character or a number, thereby defining the variation of the product)

complies with the EMC Directive 2014/30/EU according to following harmonised standards:  
EN 61000-6-2:2019, EN 61000-6-4:2019

complies with the ATEX Directive 2014/34/EU according to following standards:  
EN IEC 60079-0:2018, EN 60079-31:2014  
TÜV NORD CERT GmbH, Notified Body No. 0044. Certificate Number TÜV 15 ATEX 143744 X

NOTE: Applies only for ATEX specified actuators. Marking plate shows the CE-ATEX approval marking.

complies with the RoHS2 Directive 2011/65/EU according to the harmonised standard:  
EN 63000:2018

Nordborg, 2025-03-06

**LINAK A/S**  
John Kling, B.Sc.E.E.  
Regulatory Affairs Manager  
Authorized to compile the relevant technical documentation

This declaration of conformity is issued under the sole responsibility of the manufacturer.

Original Declaration



## DECLARATION OF CONFORMITY

LINAK A/S  
Smedevænget 8  
DK - 6430 Nordborg

Hereby declares that

Actuator (LA25 with communication interface)

25\*\*\*\*\*§\*\*\*=\*\*\*\*\*

where § can be: A, E, G, H, I, J, N, P, Q, R, S, T, U

(The "\*" in the product description can either be a character or a number, thereby defining the variation of the product)

complies with the EMC Directive 2014/30/EU according to following harmonised standards:  
EN 61000-6-2:2019, EN 61000-6-4:2019

complies with the ATEX Directive 2014/34/EU according to following standards:  
EN IEC 60079-0:2018, EN 60079-31:2014  
TÜV NORD CERT GmbH, Notified Body No. 0044. Certificate Number TÜV 15 ATEX 143744 X

NOTE: Applies only for ATEX specified actuators. Marking plate shows the CE-ATEX approval marking.

complies with the RoHS2 Directive 2011/65/EU according to the harmonised standard:  
EN 63000:2018

Nordborg, 2025-03-06

**LINAK A/S**  
John Kling, B.Sc.E.E.  
Regulatory Affairs Manager  
Authorized to compile the relevant technical documentation

This declaration of conformity is issued under the sole responsibility of the manufacturer

Original Declaration

Translation



(1) **EU-Type Examination Certificate**

(2) Equipment and protective systems intended for use in potentially explosive atmospheres, **Directive 2014/34/EU**

(3) **Certificate Number** TÜV 15 ATEX 143744 X **Issue:** 01

(4) for the product: Linear Actuator, Model: LA25 series

(5) of the manufacturer: LINAK A/S

(6) Address: Smedevænget 8, Guderup  
6430 Nordborg  
Denmark

Order number: 8003051498

Date of issue: See date of signature

(7) The design of this product and any acceptable variation thereto are specified in the schedule to this EU-Type Examination Certificate and the documents therein referred to.

(8) The TÜV NORD CERT GmbH, Notified Body No. 0044, in accordance with Article 17 of the Directive 2014/34/EU of the European Parliament and the Council of 26 February 2014, certifies that this product has been found to comply with the Essential Health and Safety Requirements relating to the design and construction of products intended for use in potentially explosive atmospheres given in Annex II to the Directive.

The examination and test results are recorded in the confidential ATEX Assessment Report No. 23 203 334681.

(9) Compliance with the Essential Health and Safety Requirements has been assured by compliance with:

**EN IEC 60079-0:2018/AC:2020-02**

**EN 60079-31:2014**

except in respect of those requirements listed at item 18 of the schedule.

(10) If the sign "X" is placed after the certificate number, it indicates that the product is subject to the Specific Conditions for Use specified in the schedule to this certificate.

(11) This EU-Type Examination Certificate relates only to the design, and construction of the specified product. Further requirements of the Directive apply to the manufacturing process and supply of this equipment. These are not covered by this certificate.

(12) The marking of the product shall include the following:

 **II 2 D Ex tb IIIC T135 °C Db**  
**II 2 D Ex tb IIIC T125 °C Db**

TÜV NORD CERT GmbH, Am TÜV 1, 45307 Essen, notified by the central office of the countries for safety engineering (ZLS), Ident. Nr. 0044, legal successor of the TÜV NORD CERT GmbH & Co. KG Ident. Nr. 0032

The deputy head of the notified body

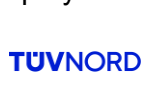
 Digital  
unterschrieben von  
Drews Anke  
Datum: 2023.12.20  
19:48:34 +01'00'

Hanover office, Am TÜV 1, 30519 Hannover, Tel. +49 511 998-61455, Fax +49 511 998-61590



(13) **SCHEDULE**

(14) **EU-Type Examination Certificate TÜV 15 ATEX 143744 X Issue 01**

(15) Description of product

The LA25 series of linear actuators creates motion in a straight line, as contrasted with circular motion of a conventional electric motor. The actuator consists of a motor, a gearbox and a spindle that causes the actuator to either extend or retract. The motor housing consists of a two part aluminium assembly with a cork gasket and an aluminium outer tube. The equipment is earthed externally through actuators fixation points: the piston rod eye and the back fixture. The actuators are rated for 12V or 24V d.c. with push / pull specifications up to 2500 N.

Type variants:

The LA25 series of linear actuators can be delivered in different type variants in accordance with the manufacturers ordering nomenclature (below). The different type variants, which do not involve the design of the motor housing itself, has no influence on the Ex-protection principle as long as the supplied power cable is delivered by the manufacturer.

Actuator type	Spindle Pitch	Stroke length	Safety	Feedback	Platform	Mototype	Endstop	IP degree	Colour	Back fixture	Back fixture	Piston rod eye	Plug type	Cable	EOS	Feedback level	Load type	Not specified	Not specified	BID	
2 5	* * *	* * *	* *	* *	*	*	*	*	II	*	*	*	*	*	*	*	*	*	*	*	***

The actuators are certified under the type LA25 including various type variants which have no influence on the ingress protection / Ex-protection principle. The manufacturers “Scheduled Drawings” specify the fixed part of the construction.

Electrical data:

Supply (brown and blue)

Type 1       $U_n = 12 \text{ V d.c. } +20\%$   
                   $I_n = 4 \text{ A}$

Type 2       $U_n = 24 \text{ V d.c. } +10\%$   
                   $I_n = 2 \text{ A}$

Signal Power supply (red and black)

$U_n = 12 - 24 \text{ V d.c.}$   
 $I_n = 40 \text{ mA}$

The permissible ambient temperature range during operation is:

T135 °C	-25 °C...+65 °C.
T125 °C	-25 °C...+55 °C.

(16) Drawings and documents are listed in the ATEX Assessment Report No. 23 203 334681.

### Schedule to EU-Type Examination Certificate TÜV 15 ATEX 143744 X Issue 01

(17) Specific Conditions for Use

1. The duty cycle is max. 20% (2 min continuous drive followed by 8 min rest).
2. Ambient temperature area are specified to -25°C to + 65°C.

T135 °C	-25 °C...+65 °C.
T125 °C	-25 °C...+55 °C.

3. The power supply cable is of special design fulfilling IP 6X ingress protection. The cable can be delivered in different lengths. Only cables delivered by LINAK A/S shall be mounted.
4. The connection between the actuator and the rest of the machine/device shall be conductive, and furthermore the application shall be grounded in order to remove any Electro Static Discharge. This counts for both of the actuator's fixation points (Back Fixture and Piston Rod Eye).
5. The cable is not UV-resistant and shall be protected from direct sunlight.
6. The supply shall be protected by a fuse according to the electrical data.
7. The Linear Actuator has to be installed in such a way, that highly effective potential electrostatic charges are prevented. The cleaning of the Linear Actuator shall be done only with a damp cloth.

(18) Essential Health and Safety Requirements

No additional ones

- End of EU-Type Examination Certificate -

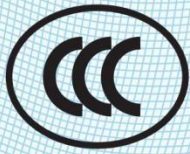

# CERTIFICATE FOR CHINA COMPULSORY PRODUCT CERTIFICATION

No.: 2024312307000953

### Applicant and address

LINAK (SHENZHEN) ACTUATOR SYSTEMS LTD.  
Floor 1-7, B1 Building, Shanghe Industrial Park, Nanchang Road, Sanwei  
Community, Hangcheng Street, Bao' an District, Shenzhen, 518126 China.

### Manufacturer and address

Linak A/S  
Smedevænget 8, Guderup, 6430 Nordborg, Denmark

### Factory and address

Linak A/S  
Smedevænget 8, Guderup, 6430 Nordborg, Denmark

### Product, series, specification and model

Actuator

25\*\*\* \*\* \* \* \* \* \* T \* \* \* \* \* \* \* \* \* \* \* \*

Ex tb IIIC T135°C Db

### Standards

GB/T 3836.1-2021, GB/T 3836.31-2021

**This product(s) complies with the requirements of CNCA-C23-01:2024  
China Compulsory Certification Implementation Rule on Explosion  
Protected Electrical Product.**

**Issue date: 2024-11-08 Valid to: 2029-11-07**

Detailed information and status of this certificate is available by using the QR code,  
visiting CNEx's website or CNCA's website: [www.cnca.gov.cn](http://www.cnca.gov.cn).

This translated document has no legal effect and shall not be used alone.



Director:

Nanyang Explosion Protected Electrical  
Apparatus Research Institute Co.,Ltd.

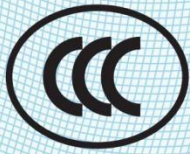

# CERTIFICATE FOR CHINA COMPULSORY PRODUCT CERTIFICATION

No.: 2024312307000953

Annex: Page 1 of 7

## Product information:

### 1. This certificate covers the following models:

- 25\*\*\* \*\* \* \* \* \* \* T \* \* \* \* \* \* \* \* \* \* \* \* \* \* \*

25	***	***	**	**	*	*	*	T	*	*	*	*	*	*	*	*	*	*	***	
a	b	c	d	e	f	g	h	i	j	k	l	m	n	o	p	q	r	s	t	u

- a: Actuator Type 25=LA25
- b: Spindle Pitch
  - 030=3mm
  - 060=6mm
  - 090=9mm
  - 120=12mm
  - 200=20mm
- c: Stroke Length, mm (20-600mm)
- d: Safety
  - 00 = None
  - 0A = Safety nut
- e: Feedback
  - 00=None
  - 0A=Hall Potentiometer (Analogue feedback)
  - 0F=PWM
  - 0K=Single Hall
- f: Platform
  - 0=None
  - 3=IC Integrated control not for openbus
  - 6=LINBUS
  - 7=CANBUS
  - 9=CANopen
  - A = IO-Link
  - B = I/O Basic
  - C = I/O Customised
  - F = I/O Full
  - X=Special
- g: Motor Type
  - A=12VDC Normal



Nanyang Explosion Protected Electrical Apparatus Research Institute Co.,Ltd.



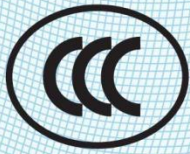

# CERTIFICATE FOR CHINA COMPULSORY PRODUCT CERTIFICATION

No.: 2024312307000953

Annex: Page 2 of 7

B=24VDC Normal

h: Endstop

0=power switch  
1=Signal switch  
2=Zero point

i: IP degree

T=CCC EX

j: Colour

=Dark Grey  
- = Black

k: Back fixture type

1 = Zink coated steel  $\varnothing$ 10.2 (0251011)  
A = Stainless  $\varnothing$ 10.2 (0251015)  
2 = Zink coated steel + bushings  $\varnothing$ 10.2  
B = Stainless + bushings  $\varnothing$ 10.2  
3 = Zink coated steel  $\varnothing$ 12.3 (0251010)  
C = Stainless  $\varnothing$ 12,3 (0251014)  
4 = Zinc coated steel + bushings  $\varnothing$  8.2  
D = Stainless steel + bushings  $\varnothing$  8.2  
5 = Zink coated steel  $\varnothing$ 10.2 + Nut (0251032)  
F = Stainless steel  $\varnothing$ 10.2 + Nut (0251034)  
6 = Zink coated steel + bushings  $\varnothing$  10.2+Nut  
G = Stainless steel + bushings  $\varnothing$  10.2+Nut  
7 = Zink coated steel  $\varnothing$ 12.3 + Nut (0251026)  
H = Stainless steel  $\varnothing$ 12.3 + Nut (0251033)  
8 = Zink coated steel + bushings  $\varnothing$ 8.2 + Nut  
I = Stainless steel + bushings  $\varnothing$ 8.2 + Nut  
M = Male adapter M12 Stainless steel (0251021)  
X=special

l: Back fixture orientation

1=0 degrees  
2=90 degrees

m: Piston Rod Eye

1 = Zink coated steel  $\varnothing$ 10.2 (0231033)  
A = Stainless  $\varnothing$ 10.2 (0231096)  
2 = Zink coated steel + bushings  $\varnothing$ 10.2  
B = Stainless + bushings  $\varnothing$ 10.2  
3 = Zink coated steel  $\varnothing$  12.3 (0231016)  
C = Stainless  $\varnothing$  12.3 (0231095)



Nanyang Explosion Protected Electrical  
Apparatus Research Institute Co.,Ltd.



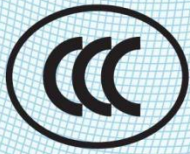

# CERTIFICATE FOR CHINA COMPULSORY PRODUCT CERTIFICATION

No.: 2024312307000953

## Annex: Page 3 of 7

- 4 = Zinc coated steel + bushings  $\varnothing$  8.2
- D = Stainless steel + bushings  $\varnothing$  8.2
- K = Ball Eye  $\varnothing$ 10H7 stainless (0351053)
- L = Ball Eye  $\varnothing$ 12H7 stainless (0351035)
- F = Female Adapter M8 stainless (0251039)
- M = Male Adapter M12 Stainless (231094)
- X = Special

### n: Plug Type

- 0 = None Is to be chosen, if cable and connectors is not wanted
- C = Flying leads Is to be chosen, if connector is not wanted
- I = Moulded Deutsch (DT4)
- J = Deutsch (DT4)
- K= AMP superseal
- L= Moulded AMP superseal
- M = M12 5P (Only IO-Link length: 0.3 m)
- S = SMPS (Only cable length 0,3 and 1,5 m)
- X = Special

### o:Cable

- 0 = None
- S = Straight 0.75m (8-core or 2-core when no feedback is needed)
- T = Straight 1.5m (8-core or 2-core when no feedback is needed)
- R = Straight 5.0m (8-core or 2-core when no feedback is needed)
- U = Straight 0.3 m (Only SMPS and IO-Link)
- V = Straight 10 m
- Y = Straight 1.5 m (11-core)
- Z = Straight 5 m (11-core)
- X = Special

### p: Endstop signal ( Endstop reached in/out)

- CAN / LIN / IO-Link
- 0 = None

### Standard

- 0 = None
- 1 = Yes

### IC Basic

- 1 = Yes

### IC Parallel (Not for I/O)

- 1 = A\_HIGH / A\_HIGH



Nanyang Explosion Protected Electrical  
Apparatus Research Institute Co.,Ltd.



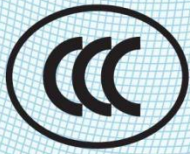

# CERTIFICATE FOR CHINA COMPULSORY PRODUCT CERTIFICATION

No.: 2024312307000953

Annex: Page 4 of 7

IC Parallel with Feedback  
X = Special

IC Advanced and I/O  
0 = None  
A = A\_HIGH / A\_HIGH  
B = A\_LOW / A\_HIGH  
C = A\_HIGH / A\_LOW  
D = A\_LOW / A\_LOW  
E = LOW / A\_HIGH  
F = HIGH / A\_HIGH  
G = LOW / A\_LOW  
H = HIGH / A\_LOW  
J = A\_HIGH / LOW  
K = A\_LOW / LOW  
L = A\_HIGH / HIGH  
M = A\_LOW / HIGH  
N = LOW / LOW  
P = HIGH / LOW  
Q = LOW / HIGH  
R = HIGH / HIGH  
X = Special

q: Feedback level by platform type  
CAN / LIN / IO-Link  
0 = none

Standard  
0 = None  
1 = 0 - 10 V  
2 = 0.5 - 4.5 V  
3 = 4 - 20 mA  
4 = 10 - 90 %  
5 = 20 - 80 %  
9 = Special feedback

IC Basic  
8 = None

IC Advanced and I/O  
0 = None  
A = 0 - 10 V



Nanyang Explosion Protected Electrical  
Apparatus Research Institute Co.,Ltd.



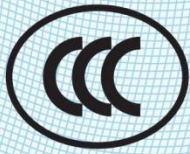

# CERTIFICATE FOR CHINA COMPULSORY PRODUCT CERTIFICATION

No.: 2024312307000953

Annex: Page 5 of 7

B = 0.5 - 4.5 V  
C = 4 - 20 mA  
D = 10 - 90% (Only IC Advanced)  
E = 20 - 80% (Only IC Advanced)  
G = 1 - 9 V  
X = Special feedback

IC Parallel (Not for I/O)  
Z = IC Parallel  
Y = Parallel with feedback  
X = Special

r: load type

0=Push/Pull  
1=Push  
2=Pull

s: Parallelmode

0=Non critical parallel  
2-8=Critical parallel

t: SW configuration

0=Standard configuration  
X=Special configuration

u: BID (mm)

Electrical data:

Supply (brown and blue)

Type 1 Un=12VDC+20%  
In=4A

Type 2 Un=24VDC+10%  
In=2A

Signal power supply (red and black)

Un=12-24VDC  
In=40mA



Nanyang Explosion Protected Electrical  
Apparatus Research Institute Co.,Ltd.



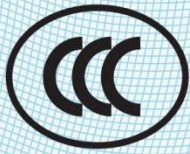

# CERTIFICATE FOR CHINA COMPULSORY PRODUCT CERTIFICATION

No.: 2024312307000953

Annex: Page 6 of 7

Ex Marking: Ex tb IIIC T135°C Db

Ingress protection: IP6X

- Manufacturer should organize production in accordance with the technical documents approved by the certification body.

## 2. Specific conditions of use:

- Ambient temperature:  $-25^{\circ}\text{C}\sim+65^{\circ}\text{C}$ .
- The duty cycle is max. 20% (2 min continuous drive followed by 8 min rest).
- The power supply cable is of special design fulfilling IP 6X ingress protection. The cable can be delivered in different lengths. Only cables delivered by LINAK A/S must be mounted.
- The connection between the actuator and the fixing points must be conductive and furthermore the application must be grounded in order to remove any electrostatic charge. This relates to both the fixing point on the motor housing and the point on the piston rod.
- The supply cable must be protected against UV-light.
- The supply must be protected by a fuse according to the electrical data.
- The Linear Actuator has to be installed in such a way, that highly effective potential electrostatic charges are prevented. The cleaning of the Linear Actuator shall be done only with a damp cloth.
- Warning - DO NOT OPEN WHEN AN EXPLOSIVE ATMOSPHERE IS



Nanyang Explosion Protected Electrical  
Apparatus Research Institute Co.,Ltd.



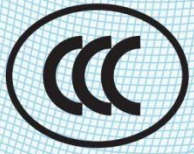

# CERTIFICATE FOR CHINA COMPULSORY PRODUCT CERTIFICATION

No.: 2024312307000953

Annex: Page 7 of 7

PRESENT !

- Warning - DO NOT SEPARATE WHEN ENERGISED !
- Warning - DO NOT OPEN WHEN ENERGISED !
- Warning - POTENTIAL ELECTROSTATIC CHARGING HAZARD: SEE INSTRUCTIONS !
- See instruction manual for other information.

**3. Certificate change information: none.**



Nanyang Explosion Protected Electrical  
Apparatus Research Institute Co.,Ltd.



# Contacts

## FACTORIES

Denmark - Headquarters  
LINAK A/S  
Phone: +45 73 15 15 15  
Fax: +45 74 45 80 48  
Fax (Sales): +45 73 15 16 13  
Web: www.linak.com

China  
LINAK (Shenzhen) Actuator Systems, Ltd.  
Phone: +86 755 8610 6656  
Phone: +86 755 8610 6990  
Web: www.linak.cn

Slovakia  
LINAK Slovakia s.r.o.  
Phone: +421 51 7563 444  
Web: www.linak.sk

Thailand  
LINAK APAC Ltd.  
Phone: +66 33 265 400  
Web: www.linak.com

USA  
LINAK U.S. Inc.  
Americas Headquarters  
Phone: +1 502 253 5595  
Fax: +1 502 253 5596  
Web: www.linak-us.com  
www.linak-latinamerica.com

## SUBSIDIARIES

Australia  
LINAK Australia Pty. Ltd  
Phone: +61 3 8796 9777  
Fax: +61 3 8796 9778  
E-mail: sales@linak.com.au  
Web: www.linak.com.au

Austria  
LINAK Zweigniederlassung - Österreich (Wien)  
Phone: +43 (1) 890 7446  
Fax: +43 (1) 890 744615  
E-mail: info@linak.de  
Web: www.linak.at - www.linak.hu

Belgium  
LINAK Actuator-Systems NV/SA  
(Belgium & Luxembourg)  
Phone: +32 (0)9 230 01 09  
E-mail: beinfo@linak.be  
Web: www.linak.be - www.fr.linak.be

Brazil  
LINAK Do Brasil Comércio De Atuadores Ltda.  
Phone: +55 (11) 2832 7070  
Fax: +55 (11) 2832 7060  
E-mail: info@linak.com.br  
Web: www.linak.com.br

Canada  
LINAK Canada Inc.  
Phone: +1 502 253 5595  
Fax: +1 416 255 7720  
E-mail: info@linak.ca  
Web: www.linak-us.com

Czech Republic  
LINAK C&S s.r.o.  
Phone: +42 058 174 1814  
Fax: +42 058 170 2452  
E-mail: info@linak.cz  
Web: www.linak.cz - www.linak.sk

Denmark - International  
LINAK International  
Phone: +45 73 15 15 15  
E-mail: info@linak.com  
Web: www.linak.com

Denmark - Sales  
LINAK Danmark A/S  
Phone: +45 86 80 36 11  
Fax: +45 86 82 90 51  
E-mail: linak@linak-silkeborg.dk  
Web: www.linak.dk

Finland  
LINAK OY  
Phone: +358 10 841 8700  
E-mail: linak@linak.fi  
Web: www.linak.fi

France  
LINAK France E.U.R.L  
Phone: +33 (0) 2 41 36 34 34  
Fax: +33 (0) 2 41 36 35 00  
E-mail: linak@linak.fr  
Web: www.linak.fr

Germany  
LINAK GmbH  
Phone: +49 6043 9655 0  
Fax: +49 6043 9655 60  
E-mail: info@linak.de  
Web: www.linak.de

India  
LINAK A/S India Liaison Office  
Phone: +91 120 4531797  
Fax: +91 120 4786428  
E-mail: info@linak.in  
Web: www.linak.in

Ireland  
LINAK UK Limited (Ireland)  
Phone: +44 (0)121 544 2211  
Fax: +44 (0)121 544 2552  
+44 (0)796 855 1606 (UK Mobile)  
+35 387 634 6554 (Rep.of Ireland Mobile)  
E-mail: sales@linak.co.uk  
Web: www.linak.co.uk

Italy  
LINAK ITALIA S.r.l.  
Phone: +39 02 48 46 33 66  
Fax: +39 02 48 46 82 52  
E-mail: info@linak.it  
Web: www.linak.it

Japan  
LINAK K.K.  
Phone: 81-45-533-0802  
Fax: 81-45-533-0803  
E-mail: linak@linak.jp  
Web: www.linak.jp

Malaysia  
LINAK Actuators Sdn. Bhd.  
Phone: +60 4 210 6500  
Fax: +60 4 226 8901  
E-mail: info@linak-asia.com  
Web: www.linak.my

Netherlands  
LINAK Actuator-Systems B.V.  
Phone: +31 76 5 42 44 40 /  
+31 76 200 11 10  
E-mail: info@linak.nl  
Web: www.linak.nl

New Zealand  
LINAK New Zealand Ltd  
Phone: +64 9580 2071  
Fax: +64 9580 2072  
E-mail: nzsales@linak.com.au  
Web: www.linak.com.au

Norway  
LINAK Norge AS  
Phone: +47 32 82 90 90  
E-mail: info@linak.no  
Web: www.linak.no

Poland  
LINAK Polska  
LINAK Danmark A/S (Spółka Akcyjna)  
Phone: +48 22 295 09 70 /  
+48 22 295 09 71  
E-mail: info@linak.pl  
Web: www.linak.pl

Republic of Korea  
LINAK Korea Ltd.  
Phone: +82 2 6231 1515  
Fax: +82 2 6231 1516  
E-mail: info@linak.kr  
Web: www.linak.kr

Slovakia  
LINAK Slovakia S.R.O.  
Phone: +421 51 7563 444  
Web: www.linak.sk

Spain  
LINAK Actuadores, S.L.u  
Phone: +34 93 588 27 77  
Fax: +34 93 588 27 85  
E-mail: esma@linak.es  
Web: www.linak.es

Sweden  
LINAK Scandinavia AB  
Phone: +46 8 732 20 00  
Fax: +46 8 732 20 50  
E-mail: info@linak.se  
Web: www.linak.se

Switzerland  
LINAK AG  
Phone: +41 43 388 31 88  
Fax: +41 43 388 31 87  
E-mail: info@linak.ch  
Web: www.linak.ch - www.fr.linak.ch  
www.it.linak.ch

Taiwan  
LINAK (Shenzhen) Actuator systems Ltd.  
Taiwan Representative office  
Phone: +886 2 272 90068  
Fax: +886 2 272 90096  
E-mail: sales@linak.com.tw  
Web: www.linak.com.tw

Turkey  
LINAK İth. İhr. San. ve Tic. A.Ş.  
Phone: +90 312 4726338  
Fax: +90 312 4726635  
E-mail: info@linak.com.tr  
Web: www.linak.com.tr

United Kingdom  
LINAK UK Limited  
Phone: +44 (0)121 544 2211  
Fax: +44 (0)121 544 2552  
E-mail: sales@linak.co.uk  
Web: www.linak.co.uk

## DISTRIBUTORS

Argentina  
Novotec Argentina SRL  
Phone: 011-4303-8989 / 8900  
Fax: 011-4032-0184  
E-mail: info@novotecargentina.com  
Web: www.novotecargentina.com

Colombia  
MEM Ltda  
Phone: +[57] (1) 334-7666  
Fax: +[57] (1) 282-1684  
E-mail: servicioalcliente@memltda.com.co  
Web: www.mem.net.co

India  
Mechatronics Control Equipments India Pvt Ltd  
Phone: +91-44-28558484, 85  
E-mail: bala@mechatronicscontrol.com  
Web: www.mechatronicscontrol.com

Indonesia  
PT. Himalaya Everest Jaya  
Phone: +6 221 544 8956 /+6 221 544 8965  
Fax: +6 221 619 1925  
Fax (Sales): +6 221 619 4658  
E-mail: hejplastic-div@centrin.net.id  
Web: www.hej.co.id

Israel  
NetivTech LTD  
Phone: +972 55-2266-535  
Fax: +972 2-9900-560  
Email: info@NetivTech.com  
Web: www.netivtech.com

Singapore  
Servo Dynamics Pte Ltd  
Phone: +65 6844 0288  
Fax: +65 6844 0070  
E-mail: servodynamics@servo.com.sg

South Africa  
Industrial Specialised Applications CC  
Phone: +27 011 466 0346  
E-mail: gartht@isagroup.co.za  
Web: www.isaza.co.za

United Arab Emirates  
Mechatronics  
Phone: +971 4 267 4311  
Fax: +971 4 267 4312  
E-mail: mechtron@emirates.net.ae

## Terms of use

LINAK® takes great care in providing accurate and up-to-date information on its products. However, the user is responsible for determining the suitability of LINAK products for a specific application. Due to continual development, LINAK products are subject to frequent modifications and changes. LINAK reserves the rights to conduct modifications, updates, and changes without any prior notice. For the same reason, LINAK cannot guarantee the correctness and actual status of imprinted information on its products.

LINAK uses its best efforts to fulfil orders. However, for the reasons mentioned above, LINAK cannot guarantee availability of any particular product at any given time. LINAK reserves the right to discontinue the sale of any product displayed on its website or listed in its catalogues or in other written material created and produced by LINAK, LINAK subsidiaries, or LINAK affiliates. All sales are subject to the 'Standard Terms of Sale and Delivery for LINAK A/S' available on LINAK websites. LINAK and the LINAK logotype are registered trademarks of LINAK A/S. All rights reserved.